

Purair® EDU™ Series Ductless Demonstration Fume Hoods

- Safe for Education, Vocational Training and Industrial Workforce Development



EDU-MOBILE, EDU-M-60



Operator



Particulate



Vapor



CONTENTS:

- Product Overview (p.2)
- Design Features (p.3)
- Performance & Selection (p.4)
- Airflow Technology (p.6)
- Specifications (p.9)
- Options & Accessories (p.12)

INTRODUCTION

The Purair EDU Series Ductless Demonstration Fume Hoods are designed to provide 360° visibility while protecting users and the classroom environment from hazardous vapors generated on and above the work surface.

APPLICATIONS

Using innovative filtration technology, the Purair EDU Series creates a safe work environment over the widest range of applications in the industry.

Science Class Lectures / Safety Practice Demonstrations / Laboratory Assignments



Deep into its second generation, Air Science embraces the diversity and cultural heritage of the founders and co-workers who are continuing a tradition of excellence. Demonstrating a commitment to adaptation, inclusion and quality output from a United States-based company with a domestic and global reach.



KEY FEATURES

- High efficiency ebm-papst EC blower.
- Energy saving LED lighting.
- Protects the operator from fume and (with added HEPA/ULPA filter) particle hazards.
- Improved filter clamping eliminates bypass leakage.
- Filter blockage alarm.

PERFORMANCE ADVANTAGE

Advanced carbon filtration technology offers a safe, high performance alternative to conventional ducted fume hoods for a broad range of applications.

Environmental Benefits. Air Science® ductless fume hoods isolate and trap chemical vapors to prevent ecological impact through release into the environment.

Versatile. Each filtration system is selected for its specific application. Carbon filters are available in more than 14 configurations for use with vapors of organic solvents, acids, mercury and formaldehyde. HEPA/ULPA filters can be added for biological safety.

Easy to Install. The ductless fume hood is self-contained and does not require venting to the outside. Many units are portable and may be moved with minimal downtime and without filter changes. Set-up, operation and filter maintenance are straightforward.

Energy Efficient. Because filtered air is returned to the room, no demands are required of the facility HVAC capacity for make-up air.

Cost Effective. Facility ductwork, HVAC and construction costs are eliminated.



EDU-MOBILE, EDU-M-40

Safe to Use. Cabinet airflow and face velocity protect users from incidental exposures to fumes.

Self-Testing. (select models) Electronic airflow monitoring assures continuous safety. An electronic gas sensor monitors carbon filter performance.

CONTENTS:

- Product Overview (p.2)
- Design Features (p.3)
- Performance & Selection (p.4)
- Airflow Technology (p.6)
- Specifications (p.9)
- Options & Accessories (p.12)



EDU-MOBILE, EDU-M-40, shown with optional duplex electrical outlet, gas petcock, cup sink and gooseneck water faucet.

DESIGN FEATURES

- A. Filter I.D. Window:** A convenient, strategically placed front cover window shows the installed filter part number and installation date to encourage timely filter replacement.
- B. Control Panel:** Electronic controls and displays include switches for the blower and filter blockage alarm.
- C. Filter Blockage Alarm:** Continuously monitors filter loading and alerts user when service is needed.
- D. Air Velometer:** An analog air velocity meter is positioned in the user's field of vision.
- E. Steel Support Frame:** The chemical resistant epoxy coated steel frame adds mechanical strength. Optional all polypropylene construction is available if desired; see accessories.
- F. Hinged Front Sash:** When closed, the cabinet sash protects the contents from inadvertent external contact and better isolates the air within. The sash is easy to open and close.
- G. Work Surface:** The internal work surface is fitted with a standard polypropylene spill tray (available in white or black). An optional stainless steel tray is also available, see accessories.
- H. Pass Through Ports:** Electrical cords and cables are safely routed into the cabinet through ports on the back.
- I. Electrostatic Pre-Filter:** The electrostatic pre-filter is accessible from inside the chamber and is 91% effective down to 1-3 microns.
- J. Filter Door Key:** Filter access keys prevent unauthorized removal or accidental exposure to dirty filters.

- K. Internal Manual Speed Controller:** Authorized personnel set the centrifugal fan motor speed as desired.
- L. Locking Casters:** Permit complete portability from lab to lab. The overall width and height are sized to fit easily through standard doorways.
- M. Isolated Single Switch Electrical Sockets:** 13 amp.
- N. Quick Release Connections:** For water, waste and gas.
- O. Petcocks and Faucet:** Available for gas and water. An optional gooseneck faucet is positioned over an optional chemically-resistant polypropylene sink cup integrated into the work surface.

ADDITIONAL FEATURES

360 Degree Visibility: Clear back and side panels allow ambient illumination into the chamber and provide users with an unobstructed view of chamber contents.

Construction: All models are available in either metal or polypropylene construction. See selection chart for specifications and dimensions. Available in 120V, 60Hz and 230V, 50Hz models.

No Installation, No Ducting Required: Self-contained, integrated systems ideal for fixed location or mobile applications.

Safe, Energy-Efficient Operation: All conditioned air is safely returned to the room, minimizing impact on facility HVAC costs.

CONTENTS:

- Product Overview (p.2)
- Design Features (p.3)
- Performance & Selection (p.4)
- Airflow Technology (p.6)
- Specifications (p.9)
- Options & Accessories (p.12)

PERFORMANCE

Air Science [Multiplex Filtration](#) offers a range of options for high performance protection.

Multiplex filter configuration permits a customized combination of filter media for a broad range of chemical families and biological agents if required.

EFT™ filtration technology broadens the Air Science application for ductless fume hoods.

A high capacity air handling system delivers face velocity of 100 fpm.

DESIGN

Professional quality Air Science fume hoods comply with current technical and safety regulations. The cabinet frame and work surfaces, comprised of industrial components, are durable and chemically resistant.

The Air Science filter assembly is easy to access, easy to change, plus a unique filter clamping design eliminates bypass leakage outside the cabinet.

The optional SafeSwitch HEPA Filter Shutter System is available for safer filter exchange.

RELIABILITY

Internal systems are isolated from fumes, extending product life.







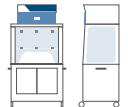
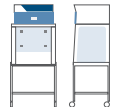

Energy-efficient centrifugal fan promotes long life and dependable performance of Purair EDU Series fume hoods.

SELECTION

Purair EDU Series products are available in 4 configurations and 6 standard sizes, in metal or polypropylene construction, totaling 12 standard models.

PURAIR EDU SERIES DIFFERENTIAL SUMMARY

	 EDU-MOBILE	 EDU-CLASSIC	 EDU-ADA	 EDU-JUNIOR
Feature				
General Description	Mounted on wheeled cart with small side storage cabinet. Blowers, filters and controls are mounted below the work surface to lower the center of gravity.	Mounted on a wheeled cart with an enclosed chemical storage area in the base cabinet.	Provides wheelchair access to the workstation front. Controls are mounted in a handheld remote box placed inside the workzone.	A basic workstation, mounted on wheeled cart.
Airflow				
Air Sampling Port	●	●	●	
Base Cabinet	●	●		
Dynamic Filter Chamber	●	●	●	
Filter Blockage Alarm	●	●	●	●
Hour Counter	●	●	●	
Optional Service Fixtures, Cup Sink	●	●	●	●
Push/Pull Handle	●	●		
Dwyer Continuous Airflow Display	●	●	●	●
Safety Filter	●	●	●	
Storage Compartment	●	●		
Track and Wheel Filter Insert/Remove Function	●	●	●	

CONTENTS:

- Product Overview (p.2)
- Design Features (p.3)
- Performance & Selection (p.4)
- Airflow Technology (p.6)
- Specifications (p.9)
- Options & Accessories (p.12)

CONTROL

The **basic control panel** is standard on the EDU-JUNIOR and includes an On/Off switch and Filter Blockage alarm.

The **advanced control panel** includes an On/Off switch, Filter Blockage alarm and hour meter to aid in determining available filter life. Standard on EDU-MOBILE, EDU-CLASSIC and EDU-ADA.

The **optional FSA/Autocal controller** displays the airflow and offers limited detection of low concentrations of hydrocarbon, some gases and organic acids. Audio and visual alarms alert users to filter saturation and if the airflow reaches preset thresholds. An Hour Counter is also included.

The **optional FSA controller** offers limited detection of low concentrations of hydrocarbon, some gases and organic acids. Audio and visual alarms alert users if filter saturation reaches preset thresholds. An Hour Counter and Low Airflow alarm are also included.

The **optional Autocal controller** displays the airflow. Audio and visual alarms alert users if the airflow reaches preset thresholds. An Hour Counter is also included.

The **optional Monitair microprocessor controller** monitors and displays cabinet operating parameters, airflow, containment and offers limited detection of low concentrations of hydrocarbon, some gases and organic acids. Audio and visual alerts if conditions become unsafe and are all displayed on a LCD screen.

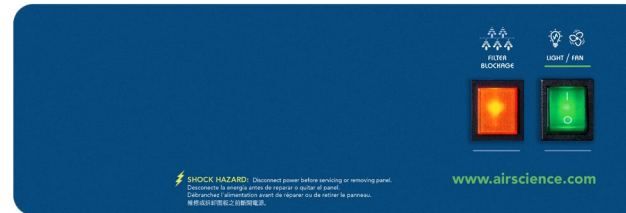

Basic Control Panel



Advanced Control Panel

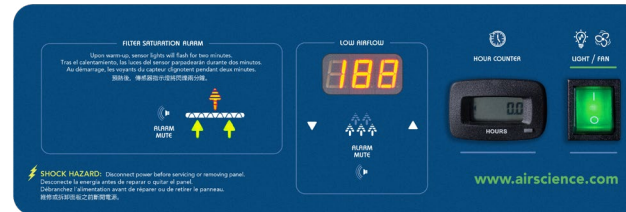

FSA/Autocal Control Panel

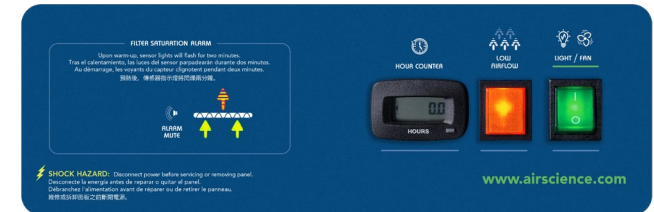

FSA Control Panel

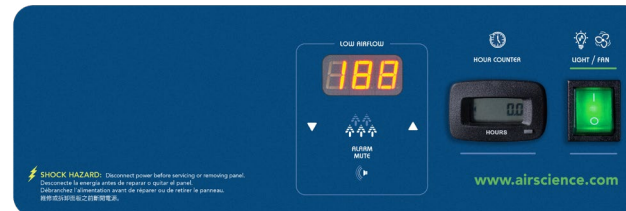

Autocal Control Panel

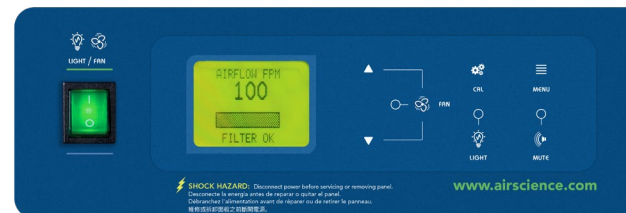

Monitair Control Panel



CONTENTS:

- Product Overview (p.2)
- Design Features (p.3)
- Performance & Selection (p.4)
- Airflow Technology (p.6)**
- Specifications (p.9)
- Options & Accessories (p.12)

multipleX™

FILTRATION

At the heart of the Purair EDU Series product line is innovative filtration technology. **The Multiplex Filtration System** consists of a pre-filter, main activated carbon or HEPA/ULPA filter and safety activated carbon or HEPA/ULPA filter. The system permits a customized combination of filter media and configuration for chemical and physical adsorption specific to each application need.

The Air Science **carbon filtration technique** is based on enhanced, activated carbon particle formulations from specially selected, naturally occurring raw material that is superior to wood or other organic sources. The carbon is treated to attain the proper porosity and aggregate surface area and to react with several ranges of aerosolized chemicals moved through the filter by an air handling blower.

View available filters and descriptions on [page 13](#).



safe SWITCH™

The optional SafeSwitch HEPA Filter Shutter system ensures that operators are safely separated from trapped contaminants during filter changes.

FILTER CONFIGURATION

The Multiplex feature permits one or more filtration options to be combined to meet a wider range of multiple-use applications.

The Purair EDU Fume Hood can be equipped with a single activated carbon main filter or with a stacked configuration which combines two main filters, each activated to adsorb one or more specific vapors or family of vapors. For safety against particulates, an optional HEPA or ULPA can also be added. When used with a HEPA/ULPA filter, the ductless fume hood may be applied as a Class I Biological Safety Cabinet.

The carbon filter is sized to fit the specified product model number and configured to optimize airflow across 100% of the filter surface area. The self-contained assembly maximizes filter efficiency, prolongs filter life, optimizes diffusion and saturation and improves user safety.

- P. Electrostatic Pre-Filter:** Protects the main filters from aerosols, mists, dust and particulates.
- C. Activated Carbon Main Filter:** A single, blended or stacked filter configuration.
- H. HEPA/ULPA Filter, Optional:** Both HEPA and ULPA filters use micro-glass fiber media designed to capture fine particles and biologicals. Both filters can capture particles smaller than the micron size for which they are tested. HEPA and ULPA filter efficiencies are 99.97% at 0.3 microns and 99.999% at 0.12 microns respectively.

MULTIPLYX FILTRATION SYSTEM, SUMMARY

Application	Chemical	Powder/ Biological	Chemical & Powder	Chemical within Cleanroom
Safety Filter, Optional	C	H	H or C	H
Primary Filter	C	H	H C	H C
Pre-Filter	P	P	P	P

The system can be configured for the capture of acids, bases, and particulates, such as biological aerosols, when paired with HEPA or ULPA filters.



EDU-ADA, P10XL-CART-RC-P

CONTENTS:

- Product Overview (p.2)
- Design Features (p.3)
- Performance & Selection (p.4)
- Airflow Technology (p.6)**
- Specifications (p.9)
- Options & Accessories (p.12)

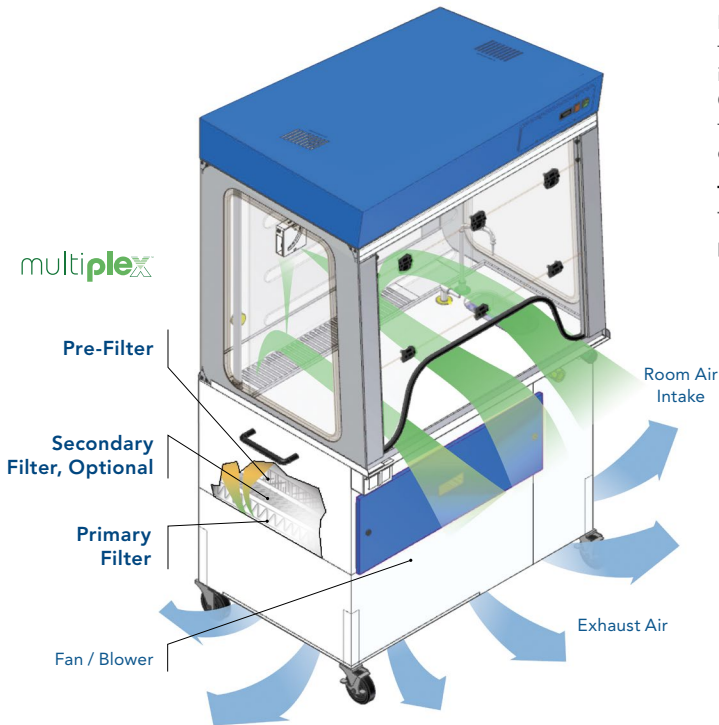

EDU-MOBILE
DOWNFLOW

AIRFLOW

Purair EDU Series fume hoods maintain a constant face velocity of 100 FPM in compliance with U.S.A. and international standards for safety and performance. Contaminated air is pulled through the Multiplex filtration system where activated carbon adsorbs chemical vapors, returning clean air to the room.

The main filters are easy to replace; no tools required. The filter clamps tightly against the filter gasket to prevent filter bypass and to maintain filter integrity.

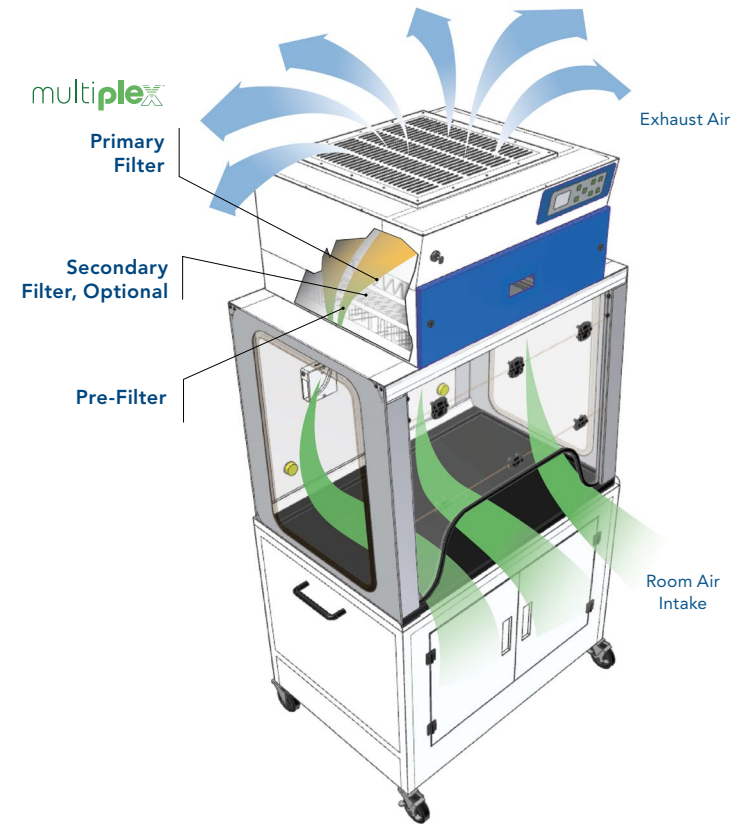

EDU-CLASSIC, EDU-ADA and EDU-JUNIOR
UPFLOW

CONTENTS:

- Product Overview (p.2)
- Design Features (p.3)
- Performance & Selection (p.4)
- Airflow Technology (p.6)**
- Specifications (p.9)
- Options & Accessories (p.12)



ENHANCED FILTRATION

The Air Science Enhanced Filtration Technology (EFT) is a universal filtration system developed for use with a wide range of core chemical families. These include organic acids, alcohols, aliphatic hydrocarbons, aromatic hydrocarbons, esters, aldehydes, ketones, ethers, halogens and others. Although the EFT system is weighted to accommodate these families, it can handle inorganic acids as well.

The Air Science EFT system is available as an option on Air Science Purair EDU series ductless fume hoods.

Independent Test Results Independent testing confirms that the Air Science EFT system is superior in critical areas to other “green” fume hood systems recently introduced to the industry. AFNOR NFX 15-211 requires that three chemicals (isopropanol, cyclohexane and hydrochloric acid) be tested under very precise conditions to ascertain and establish retention capacity at 1% of the threshold limit value (TLV) for each chemical.

Retention capacity (grams) for a single module at 1% of the TLV (Threshold Limit Value)

Specification	AFNOR NFX 15-211	
	IBR	Intertek
Testing Laboratory		
Product Manufacturer	Air Science	Brand E
Filter Type		Green
Test Results	EFT	
Isopropanol (alcohol)	2052	673
Cyclohexane (aliphatic hydrocarbon)	1531	914
Hydrochloric acid (inorganic acid)*	1205	2729*

**Based on “core” chemical families typically used in ductless fume hood applications, the Air Science EFT filter offers significant advantages over filters marketed as “universal” filters. With moderate to heavy acid applications, all ductless fume hoods made of metal are subject to corrosion and rust. On inorganic acids, the EFT filter provides a lesser, but more realistic, usable capacity.*

SECUR.
safe disposal service

Filter disposal services are available in selected markets providing responsible destruction or recycling of saturated filters in authorized facilities.



Through our partner company [Filtco Filters](#), Air Science is a single source supplier of all pre-filters, carbon filters and HEPA/ULPA filters used in our products.



Avoid Revolving Filters Air Science strongly discourages the unsafe practice of revolving secondary backup filters into the primary filter compartment. All Air Science units are designed to avoid this false sense of security.

In a revolving filter system, users are instructed to rotate the secondary backup filter into the primary filter position after non-permissible exposure levels of chemicals are detected within the monitoring chamber.

Depending on when the unit can be properly shut down, the secondary filter can be loaded to the point of saturation itself, thereby creating a safety hazard if the filter is considered new.

If a new spare filter is not immediately available, a user may inadvertently (or knowingly) re-install a contaminated primary filter into the secondary location permitting the system to operate without protection.

Additionally, the secondary filter can become contaminated as it ages, sometimes for years, on top of an operational cabinet, losing filter efficiency by the time it is installed.

Either practice puts both personnel and the environment at risk, even though some manufacturers provide stickers to label the filters as “used.”

The Air Science non-revolving filter practice ensures that only a new filter is fitted into the primary filter compartment and permits the secondary filter to remain installed for at least twice the change-out period, resulting in a 50% savings in filter change-out costs.

CONTENTS:

- Product Overview (p.2)
- Design Features (p.3)
- Performance & Selection (p.4)
- Airflow Technology (p.6)
- Specifications (p.9)
- Options & Accessories (p.12)

EDU-MOBILE

The EDU-MOBILE is mounted on a wheeled cart with a small side storage compartment. Blowers, filters and controls are mounted beneath the work surface to lower the center of gravity and simplify moving the unit from room to room.

EDU-MOBILE, EDU-M-40

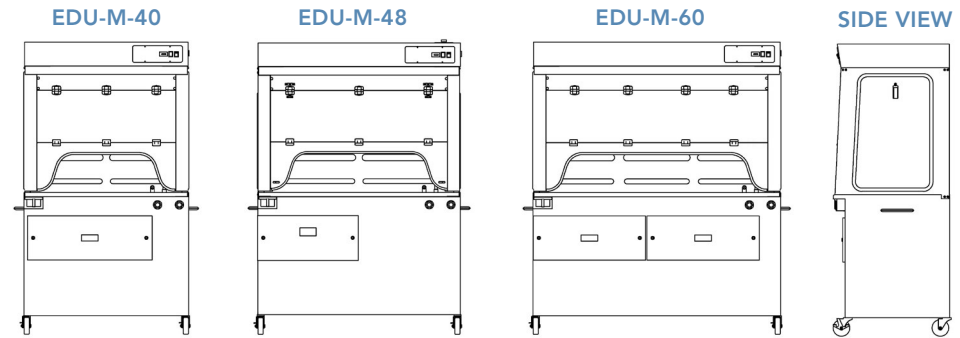

MODEL	DIMENSIONS			WEIGHT (LBS/KG)	
	Internal Height	External (W × D × H)	Shipping (W × D × H)	Net	Ship
EDU-MOBILE					
EDU-M-40	38" / 965 mm	39.5" × 27.4" × 78" / 1003 × 695 × 1981 mm	48" × 40" × 90" / 1219 × 1016 × 2286 mm	270 / 122	320 / 145
EDU-M-48	38" / 965 mm	49.2" × 27.4" × 78" / 1250 × 695 × 1981 mm	60" × 40" × 90" / 1524 × 1016 × 2286 mm	370 / 168	420 / 191
EDU-M-60	38" / 965 mm	59.5" × 27.4" × 78" / 1511 × 695 × 1981 mm	72" × 40" × 90" / 1829 × 1016 × 2286 mm	470 / 213	520 / 236

CONTENTS:

- Product Overview (p.2)
- Design Features (p.3)
- Performance & Selection (p.4)
- Airflow Technology (p.6)
- Specifications (p.9)
- Options & Accessories (p.12)



EDU-CLASSIC

The EDU-CLASSIC has horizontal inflow with top mounted filters and exhaust. This model is mounted on a wheeled cart with an enclosed chemical storage area in the cabinet base.

P15-XT-CART-MCC-40

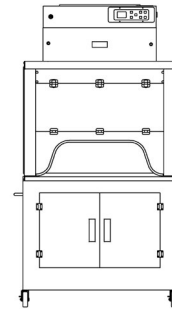

SIDE VIEW

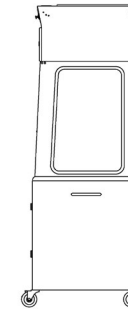

EDU-CLASSIC, P15-XT-CART-MCC-40

MODEL	DIMENSIONS			WEIGHT (LBS/KG)	
	Internal Height	External (W x D x H)	Shipping (W x D x H)	Net	Ship
EDU-CLASSIC P15-XT-CART-MCC-40	38" / 965 mm	39.5" x 28.5" x 87" / 1003 x 724 x 2210 mm	48" x 40" x 93" / 1219 x 1016 x 2362 mm	350 / 159	425 / 193

CONTENTS:

- Product Overview (p.2)
- Design Features (p.3)
- Performance & Selection (p.4)
- Airflow Technology (p.6)
- Specifications (p.9)
- Options & Accessories (p.12)



EDU-ADA

The EDU-ADA permits wheelchair access to the workstation. Controls are mounted in a handheld remote box that can be placed adjacent to or inside the work area.

P10XL-CART-RC-P

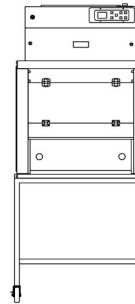

SIDE VIEW

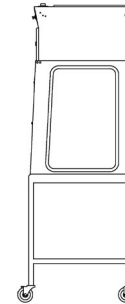

EDU-ADA, P10XL-CART-RC-P

MODEL	DIMENSIONS			WEIGHT (LBS/KG)	
	Internal Height	External (W x D x H)	Shipping (W x D x H)	Net	Ship
EDU-ADA					
P10XL-CART-RC-P	38" / 965 mm	34" x 27.4" x 87" / 864 x 695 x 2210 mm	48" x 40" x 90" / 1219 x 1016 x 2286 mm	234 / 106	284 / 129

CONTENTS:

- Product Overview (p.2)
- Design Features (p.3)
- Performance & Selection (p.4)
- Airflow Technology (p.6)
- Specifications (p.9)
- Options & Accessories (p.12)



EDU-JUNIOR

The EDU-JUNIOR is a basic workstation mounted on a wheeled cart.

P5-24-XT-CART

SIDE VIEW

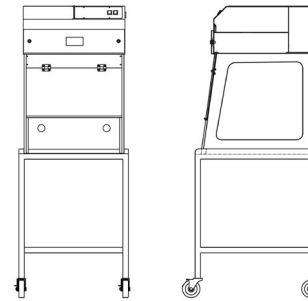

EDU-JUNIOR, P5-24-XT-CART

MODEL	DIMENSIONS			WEIGHT (LBS/KG)	
	Internal Height	External (W x D x H)	Shipping (W x D x H)	Net	Ship
EDU-JUNIOR					
P5-24-XT-CART	24" / 610 mm	24" x 27" x 70" / 610 x 686 x 1778 mm	40" x 40" x 80" / 1016 x 1016 x 2032 mm	176 / 80	225 / 102

CONTENTS:

- Product Overview (p.2)
- Design Features (p.3)
- Performance & Selection (p.4)
- Airflow Technology (p.6)
- Specifications (p.9)
- Options & Accessories (p.12)

PRODUCT SPECIFICATIONS

Purair EDU Series	EDU-MOBILE		EDU-CLASSIC	EDU-ADA	EDU-JUNIOR	
Filtration	EDU-M-40	EDU-M-48	EDU-M-60	P15-XT-CART-MCC-40	P10XL-CART-RC-P	P5-24-XT-CART
Pre-Filter	100 fpm	100 fpm	100 fpm	100 fpm	100 fpm	100 fpm
Construction						
Construction	<... White epoxy steel frame and head unit, clear sides and back panel. ...>					
Blower	<... Centrifugal fan. ...>					
Controls	<... Main On/Off. ...>					
Electrical	<... 120V, 60Hz or 230V, 50Hz voltages available. Specify when ordering. Other voltage options available. ...>					
Monitoring	<... Filter blockage alarm, standard. ...>					

FILTER SPECIFICATIONS

Purair Model	EDU-M-40	EDU-M-48	EDU-M-60	P15-XT-CART-MCC-40	P10XL-CART-RC-P	P5-24-XT-CART
Safety Filter, Optional*	(1)	(1)	(1)	(1)	(1)	(1)
Primary Filter(s)*	(1)	(2)	(2)	(1)	(1)	(1)
Pre-Filter*	(1)	(1)	(1)	(1)	(1)	(1)

* For specific examples refer to Multiplex filtration system summary on [page 6](#).

FILTER SUMMARY*

Formula	Description
GP Plus!	The most widely used filter in the range, primarily for solvent, organic and alcohol removal.
ACI Plus!/SUL	Designed to neutralize volatile inorganic acid vapors.
ACR	Iodine and methyl iodide vapors; It is frequently used for iodination reactions with lower level radioactive iodine.
ACM	Mercury vapor.
AMM	Removes vapors from dilute ammonia solutions and to remove low molecular weight amines.
FOR	Designed to oxidize formaldehyde and glutaraldehyde fumes; It is widely used in hospital pathology laboratories.
HEPA/UPLA	Powders and particulates.
	Universal filtration.

*Other formulas may be available.

CONTENTS:

- Product Overview (p.2)
- Design Features (p.3)
- Performance & Selection (p.4)
- Airflow Technology (p.6)
- Specifications (p.9)
- Options & Accessories (p.12)

OPTIONS & ACCESSORIES

		EDU-MOBILE			EDU-CLASSIC	EDU-ADA	EDU-JUNIOR
Air Science Model		EDU-M-40	EDU-M-48	EDU-M-60	P15-XT-CART-MCC-40	P10XL-XT-CART-RC-P	P5-24-XT-CART
Safety Filter	An additional carbon, HEPA or ULPA safety filter exceeding ANSI/AIHA Z9.5 requirements can be installed after the main filter.	<... Safety filters for vapor or particulate protection are available for all models. ...> Contact Air Science for ordering information.					
FSA/Autocal Controller*	The optional FSA/Autocal controller displays the airflow and offers limited detection of low concentrations of hydrocarbon, some gases and organic acids. Audio and visual alarms alert users to filter saturation and if the airflow reaches preset thresholds. An Hour Counter is also included.	ADV-P	ADV-P	ADV-P	ADV-P	ADV-P	ADV-P
FSA Controller*	The optional FSA controller offers limited detection of low concentrations of hydrocarbon, some gases and organic acids. Audio and visual alarms alert users if filter saturation reaches preset thresholds. An Hour Counter and Low Airflow alarm are also included.	FSA	FSA	FSA	FSA	FSA	FSA
Autocal Controller*	The optional Autocal controller displays the airflow. Audio and visual alarms alert users if the airflow reaches preset thresholds. An Hour Counter is also included.	AUTOCAL	AUTOCAL	AUTOCAL	AUTOCAL	AUTOCAL	AUTOCAL
Monitair Controller*	The optional microprocessor controller monitors and displays cabinet operating parameters, airflow, containment and offers limited detection of low concentrations of hydrocarbon, some gases and organic acids. Emits audio and visual alerts if conditions become unsafe and are all displayed on a LCD screen. Not TUV compliant.	MON-P	MON-P	MON-P	MON-P	MON-P	--
Spill Tray (Stainless)	Removable for easy cleaning.	--	--	--	TRAY-P15-SS	TRAY-P10XL-SS	TRAY-P5-24XT-SS
SafeSwitch HEPA Filter Shutter System	Minimizes exposure to filter contaminants when removing used HEPA filters for insertion of new filters.	ASTM-030-SS	ASTM-030-SS	ASTM-030-SS	ASTM-030-SS	ASTM-030-SS	ASTS-030-SS
Polypropylene Construction*	Cabinets are available in all polypropylene construction. Contact Air Science for information.	--	--	--	P15-PP-CART-SSC-40	P10XL-PP-CART-RC	P5-24XT-PP-CART
Duplex Electrical Outlet*	Two NEMA 14-20R receptacles with ground fault interrupter. 110V service standard; international fixtures available.	AS-GFI	AS-GFI	AS-GFI	AS-GFI	AS-GFI	AS-GFI
Utilities Package*	Polyethylene cup sink (3" x 5" x 9"), faucet, service fixtures such as petcocks or valves. Other sizes and materials available. Specify when ordering.	WATER-EDU	WATER-EDU	WATER-EDU	WATER-EDU	WATER-EDU	WATER-EDU
Docking Station*	Security cable is shorter than utility and power line. Prevents damage from accidental disconnect of utility services to mobile fume hoods. Can be recessed or flush mounted. Includes key lock, quick release connections for water, waste and gas. An optional RJ45 outlet is available. Specify outlet choice when ordering.	DOCK-S	DOCK-S	DOCK-S	DOCK-S	DOCK-S	DOCK-S
Sliding Sash*	Vertical sliding sash permits easier access to the work surface when the mobile fume hood is used in limited space areas. Specify when ordering.	SSASH-P15	SSASH-P20	SSASH-P25	SSASH-P15	--	--
Dual Access*	Units can be fitted with dual access front and rear panels for applications where student access is required.	--	--	--	DSASH-P15	DSASH-P10XL	DSASH-P524-XT

* Factory installed; specify when ordering.

CONTENTS:

- Product Overview (p.2)
- Design Features (p.3)
- Performance & Selection (p.4)
- Airflow Technology (p.6)
- Specifications (p.9)
- Options & Accessories (p.12)

WARRANTY

This product is protected by the Air Science Legacy Limited Lifetime Warranty™.



For details visit the [Warranty section](#) of our website.

STANDARDS & COMPLIANCE

Quality Management Systems	ISO 9001:2015
Electrical Safety	UL-C-61010-1 CAN/CSA C22.2 61010-1-12 EN 61010-1:2010 CE Mark
OSHA, Occupational Safety and Health Administration	OSHA Standard -29 CRF, Safety and Health Regulations for General Industry, 1910.1450: Occupational exposure to hazardous chemicals in laboratories. Part B, definition, laboratory type hood. This product may assist you with compliance or as part of your chemical hygiene plan. Please consult your Safety Officer and/or Industrial Hygienist.
Environment	ISO 14001:2015 ENERGY STAR® Partner
Education (UK)	CLEAPPS Instruction Approved (EDU) based on ASTM-100 filter.



120 6th Street \ Fort Myers, FL 33907
T. 239-489-0024 \ **Toll Free.** 800-306-0656 \ **F.** 800-306-0677
www.airscience.com

The information contained in this manual and the accompanying product are copyrighted and all rights are reserved by Air Science. Air Science reserves the right to make periodic minor design changes without obligation to notify any person or entity of such change.

