

# **INSTRUCTION MANUAL**

## **Sound Level Meter**

### **NL-27**



3-20-41 Higashimotomachi, Kokubunji, Tokyo 185-8533, Japan  
<http://www.rion.co.jp/english/>

# FOR SAFETY

In this manual, important safety instructions are specially marked as shown below. To prevent the risk of death or injury to persons and severe damage to the unit or peripheral equipment, make sure that all instructions are fully understood and observed.



Disregarding instructions printed here incurs the risk of damage to the product.

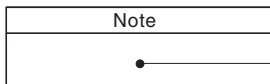

Mentioned about the tips to use this unit properly. (This messages do not have to do with safety.)

This product can be used in any areas including residential areas.

To conform to the EU requirement of the Directive on Waste Electrical and Electronic Equipment, the symbol mark on the right is shown on the instrument.



# Precautions

- Operate the unit only as described in this manual.
- Do not touch any parts of the unit other than necessary for operation.
- Do not drop the unit. Protect it from shocks and vibration.
- The permissible environmental temperature range for operation of the unit is -10 to +50°C. Relative humidity must be between 10% and 90%.
- Do not use or store the unit in locations which may be subject to water, direct sunlight, high temperatures or humidity. Also protect the unit from air with high salt or sulphur content, gases or the influence of chemicals.
- Do not forget to turn the unit off after use. Remove the batteries if the unit is not to be used for some time.
- When disconnecting cables, always hold the plug and do not pull the cable.
- To clean the unit, use only a dry cloth or a cloth lightly moistened with water. Do not use chemical cleaning cloths, solvents or alcohol-based cleaners to prevent the possibility of deformation and discoloring.
- Do not insert any objects such as pins, metal scraps, conducting plastic etc. into any opening on the unit.
- Do not disassemble the unit or attempt internal alterations.
- In case of malfunction, do not attempt any repairs. Note the condition of the unit clearly and contact the supplier.
- When disposing of the unit or the batteries, follow national and local regulations regarding waste disposal.

# Contents

Precautions .....	i
Outline .....	1
Controls and Functions .....	2
Batteries .....	4
Attachments .....	6
Windscreen .....	6
Windscreen fall out prevention rubber.....	6
Silicone cover.....	7
Hand strap.....	8
Connecting external equipment .....	9
State transition diagram (functions and operation keys).....	10
Measurement screen and processing screen.....	12
Power on and off .....	14
Measurement.....	14
Calibration .....	15
Menu settings .....	16
Sleep mode .....	18
Recalling stored data.....	19
Initializing.....	20
Specifications .....	21
Description for IEC 61672-1 .....	26
IEC61672-1 (JIS C 1509-1) Frequency Response.....	37
Reference incidence direction and reference point position.....	39
Frequency Response .....	39
Effect of Windscreen WS-14 .....	40
The greatest susceptibility configuration for radio frequency fields .	42
Statement of conforming to the basic statement .....	43
Adjustment data for sound calibrator .....	43
The lower and upper limits of the linear operating range.....	43
Directional Characteristics .....	44
Random incidence response.....	46

## Outline

This unit is a sound level meter that complies with the Japan measurement law, JIS, and IEC. The microphone is a 1/2-inch electret condenser (UC-52). It has a wide 107-dB linearity range, measuring sound levels between 30 and 130 dB, with no need to select the range. The unit has an LCD panel, operation keys, an AC monitor output connector, a DC out connector, and a USB connector. It is able to measure the following items.

- Sound level  $L_p$
- Equivalent continuous sound level  $L_{eq}$
- Maximum sound level  $L_{max}$
- Sound exposure level  $L_E$
- C weighted peak sound level  $L_{Cpeak}$

You can send data you have stored with the manual store function through a USB adapter cable (optional accessory) to a computer. It is powered by two size AAA batteries. The main unit and preamplifier are a single unit so it is not possible to extend the microphone.

This unit has the following two level ranges.

**Wide range:** This measures the range between 30 and 137 dB and allows simultaneous measurement of  $L_p$ ,  $L_{eq}$ ,  $L_{max}$ , and  $L_E$ .

**Peak range:** Along with the processing results for wide range, this range also measures  $L_{Cpeak}$ , but the lower limit for measurement becomes 65 dB.

## Resume function

The following items maintain the same settings they had when you turn the unit off the next time you turn the unit on.

- Measurement time
- Time weighting characteristics
- Level range
- Address indication

The following items have predefined settings upon startup.

- Frequency weighting characteristic A
- Display processing value type  $L_p$

## Controls and Functions Front Panel

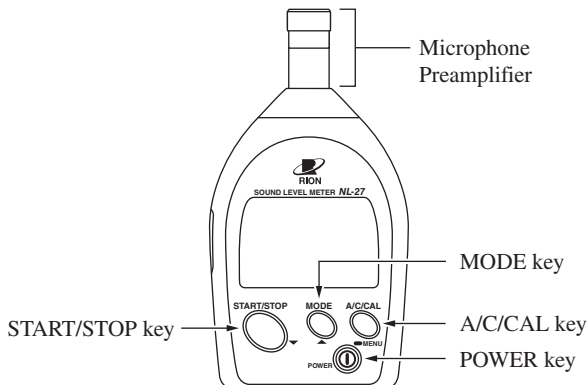

### Microphone/preamplifier

Microphone and preamplifier are integrated in a single enclosure. An extension cable cannot be used.

### START/STOP key

Press to start or stop processing. Also used to change setting values in the calibration screen, menu screen, and recall screen.

### MODE key

Changes the processing result display in the measurement screen and processing screen. Also used to change setting values in the calibration screen, menu screen, and recall screen.

### A/C/Cal key

This key selects the frequency weighting characteristics, calibration screen and recall screen. Pressing and holding this key in the measurement screen changes it to the menu screen.

### POWER key

Turns the unit on and off.

## Side View

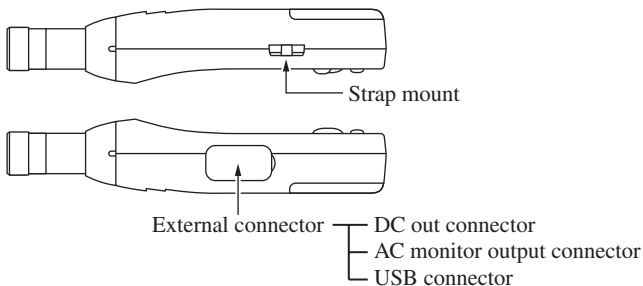

### External connector

This connector is composed of a DC out connector, an AC monitor output connector, and a USB connector. (The connector can only be used for one purpose at a time.)

### DC out connector

A DC signal corresponding to the sound level can be output from here. The signal after frequency weighting, time weighting, and logarithmic compression is output here (constant output when a DC output cable is connected). Connect the unit with the optional DC output cable to external equipment.

### AC monitor output connector

An AC signal weighted with frequency weighting characteristic Z is output here (constant output when an AC monitor output cable is connected). Connect the unit with the optional AC monitor output cable to external equipment.

When 110 dB is displayed, output is  $1 \text{ Vrms} \begin{matrix} +600 \text{ mVrms} \\ -400 \text{ mVrms} \end{matrix}$ .

(The upper limit of the output voltage is 1.8 Vrms)

### USB connector

Connect the unit with the optional USB adapter cable to computer and send stored data. (Download the necessary software from our web site.)

### Strap mount

Attach the hand strap here (see page 8). Pass your wrist through this strap when holding the unit for measuring.

## Rear View

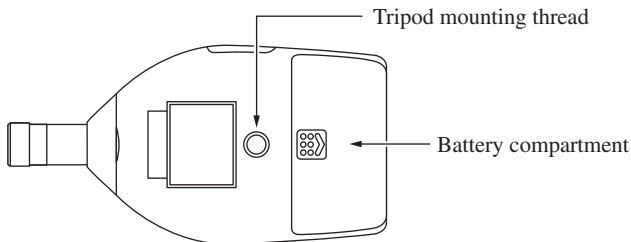

### Tripod mounting thread

Mount the unit on a camera tripod with this thread.

### Battery compartment

Insert two size AAA (IEC R03, LR03) batteries here.

## Batteries

### Inserting the Batteries

#### Important

Make sure the unit is turn off before inserting the batteries.

1. Remove the battery compartment cover on the rear of the unit.
2. Insert two size AAA (IEC R03, LR03) batteries into the battery compartment. Insert correctly as indicated in the compartment.
3. Replace the battery compartment cover.

Press and pull in the arrow direction

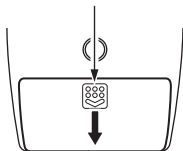

Remove the battery compartment cover

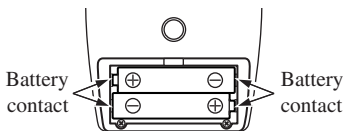

Insert two size AAA  
(IEC R03, LR03) batteries



**Important**

Take care not to reverse the (+) and (-) polarity when inserting the batteries. If batteries are inserted with wrong polarity, the unit will not operate.

Always use two identical batteries, and replace batteries only as a set. Mixing battery types or old and new batteries can lead to damage.

Remove the batteries from the unit when it is not used.

Do not subject the battery connectors to strong force or stress. Damaged springs can lead to loss of proper battery contact.

**Battery life** (at 23°C, using wide range)

Manganese batteries: approx. 3 hours

Alkaline batteries: approx. 9 hours

Battery life will be reduced by 20% when a DC output cable is connected.

**Battery indication**

Indicates battery charge. When the indicator starts to flash, correct measurement is no longer possible. Replace the batteries with fresh ones.

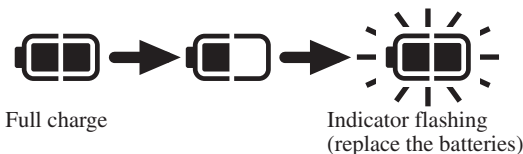
**Important**

If the indicator starts flashing during processing, processing will end at that point.

You cannot start processing with the START/STOP key when the battery indication is flashing.

## Attachments

### Windscreen

We recommend attaching the windscreen to reduce wind noise.

### Windscreen fall out prevention rubber (hereafter called “fall out prevention rubber”)

Prevents the windscreen from dropping off the microphone.  
This is attached to the unit at the time of shipment.

Important
The windscreen can easily drop off the unit, so we recommend attaching the fall out prevention rubber.
Be sure to follow the instructions in the following diagram when attaching or detaching the fall out prevention rubber. Turning it in the opposite direction may loosen the microphone and cause it to fall off.

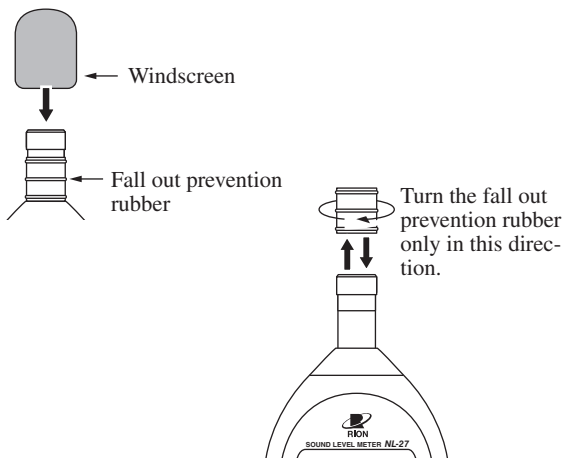

## Silicone cover

The silicone cover protects the unit from shocks and also makes it easier to grip when held.

Fit it to the unit with the windscreen removed, as shown in the following diagram.

### Note

You cannot use external connector when the silicone cover is fitted.

You can attach the hand strap to the silicone cover strap mount.

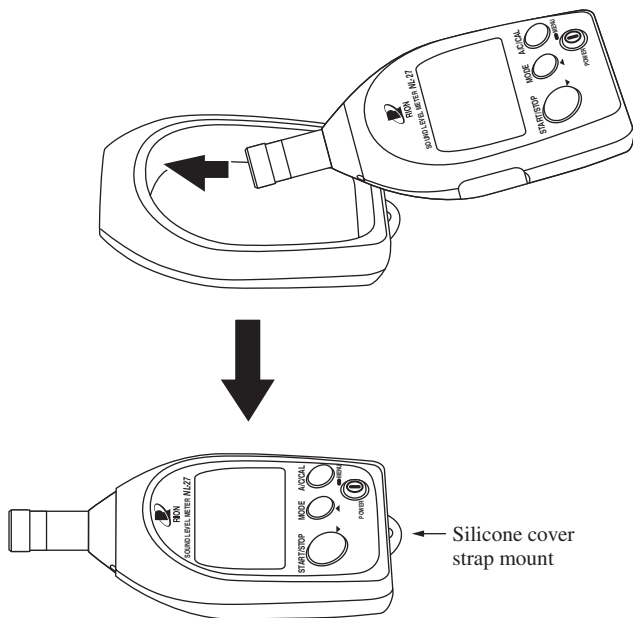

## Hand strap

To help prevent dropping of the unit, pass your wrist through this strap when holding the unit for measuring. Attach the hand strap as shown below.

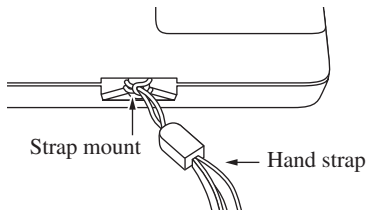

When you have not fitted the silicone cover

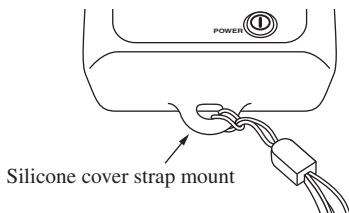

When you have fitted the silicone cover

Note
Attach the hand strap to the silicone cover if you have fitted the unit with the silicone cover.

## Connecting external equipment

You can connect external equipment, such as a data recorder, level recorder, or computer, to the external connector. Connect as shown in the following diagram.

### Note

The connector has the ability to act as a DC output connector, an AC monitor output connector, or a USB connector, but it can perform only one of these functions at a time.

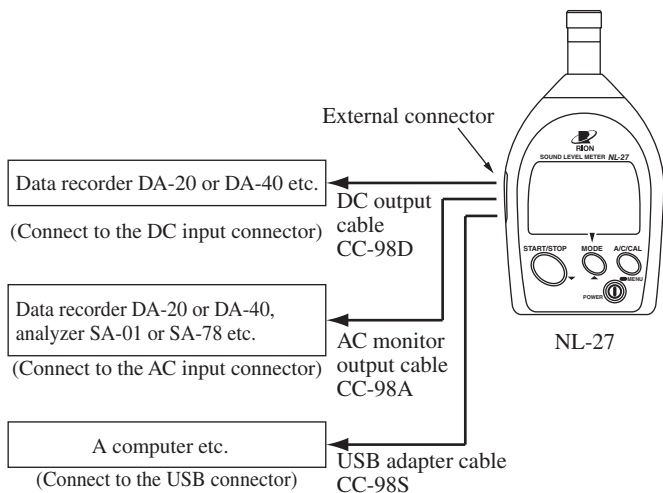

## State transition diagram (functions and operation keys)

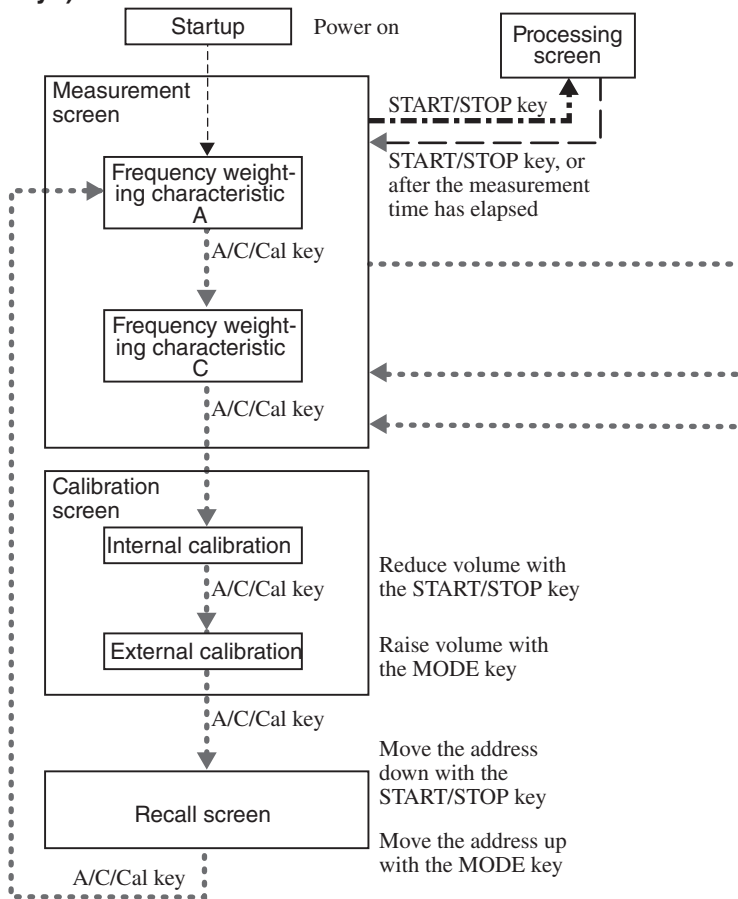

Pressing the MODE key in the measurement screen or processing screen changes the display in the following order.

$L_p \Rightarrow L_{eq} \Rightarrow L_{max} \Rightarrow L_E (\Rightarrow L_{Cpeak}) \Rightarrow L_p$

$L_{Cpeak}$  only appears when peak range is selected.

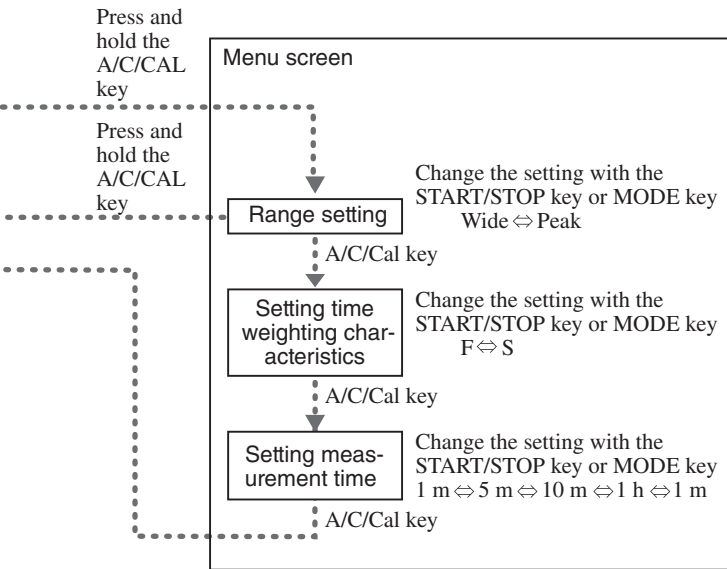

## Measurement screen and processing screen

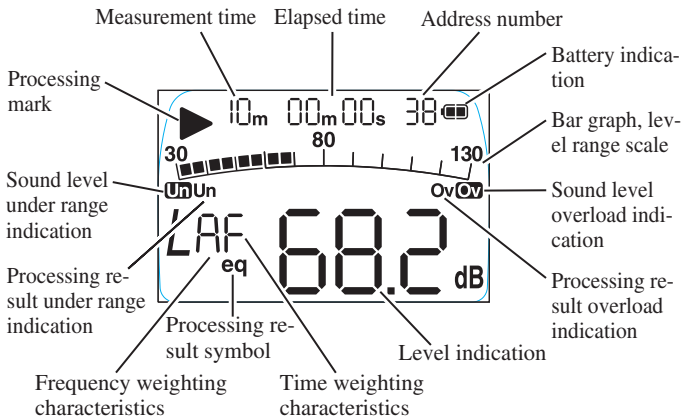

### Measurement time

The measurement time set in the menu screen (see state transition diagram, page 11).

### Elapsed time

The amount of time elapsed since processing started.

### Address number

The address where the processing result (the next process result in the measurement screen) is stored.

### Battery indication

Indicates battery charge. (see page 5)

### Bar graph, level range scale

Shows the sound level in a bar graph.

### Sound level overload indication

Shows that the sound level has exceeded the measurement range.



## Processing result overload indication

Appears during processing when the sound level exceeds the measurement range, and remains until the next process starts (when a processing result is shown).

## Level indication

Shows the sound level ( $L_p$ ) and each processing result ( $L_{eq}$ ,  $L_{max}$ ,  $L_E$ , and  $L_{Cpeak}$ ) as digits. Switch the display with the MODE key.

$L_{Cpeak}$  is processed and shown only when peak range (see page 16) is selected.

## Time weighting characteristics

Shows the time weighting characteristics selected in the menu screen.

## Processing result symbol

Shows the relevant symbol for the displayed processing result ( $L_{eq}$ ,  $L_{max}$ ,  $L_E$ , or  $L_{Cpeak}$ ).

## Frequency weighting characteristics

Change with the A/C/CAL key. See the state transition diagram (page 10).

## Processing result under range indication

If the sound level falls below the measurable limit (-0.6 dB) during processing, this appears until the next process starts (when a processing result is shown).

## Sound level under range indication

Appears when the sound level falls below the measurable limit (-0.6 dB).

## Processing mark

Flashes during processing.

## Power on and off

Press the POWER key for 0.5 seconds or more to turn the power on or off.

## Measurement

### Selecting frequency weighting characteristics

In the measurement screen, press the A/C/CAL key to select either frequency weighting characteristic A or C. (See the state transition diagram on page 10)

### Processing (measurement)

Press the START/STOP key to start the processing.

The processing mark flashes during processing. Additionally, pressing the MODE key switches the display to show processing results ( $L_p$ ,  $L_{eq}$ ,  $L_{max}$ ,  $L_E$ , or  $L_{Cpeak}$ ) made up to that point.

Processing stops when the measurement time elapses or you press the START/STOP key.

### Storing processing data

When processing stops, the  $L_{eq}$ ,  $L_{max}$ ,  $L_E$ , or  $L_{Cpeak}$  processing results are automatically stored, and the address number increases by one.

## Calibration

### Internal calibration (calibration with an electronic signal)

Calibration with the built-in oscillator (1 kHz, sinusoidal wave). In the measurement screen, press the A/C/CAL key to switch to the internal calibration screen.

(See the state transition diagram on page 10)

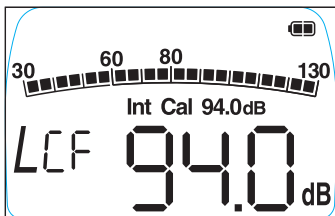

Internal calibration screen “Int”, “Cal”, and “94.0dB” appear on the display. The frequency weighting characteristic is fixed to C and the time weighting characteristic is fixed to F.

Press the START/STOP key (Down) or MODE key (Up) to adjust the volume to 94.0 dB.

### Acoustic calibration (calibration with a sound calibrator)

Use optional sound calibrator NC-74.

In the internal calibration screen, press the A/C/CAL key to switch to the acoustic calibration screen.

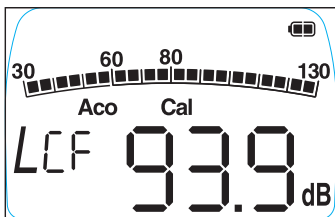

Acoustic calibration screen “Aco” and “Cal” appear on the display. The frequency weighting characteristic is fixed to C and the time weighting characteristic is fixed to F.

Attach the microphone to NC-74 and turn NC-74 on. Wait at least 30 seconds, then press the START/STOP key (Down) or MODE key (Up) to adjust the volume to 93.9 dB.

## Menu settings

In the measurement screen, press and hold the A/C/CAL key to switch to the menu screen (not available during processing).

### Range setting

Press the START/STOP key or the MODE key to select the following range settings.

Wide: Measurement range: 30 to 130 dB,  $L_{Cpeak}$  cannot be processed

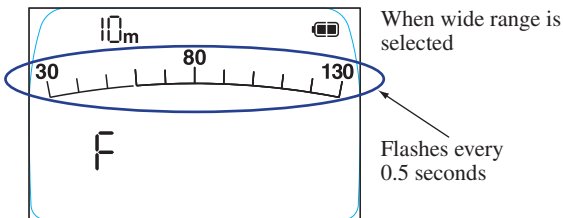

Peak: Measurement range: 65 to 130 dB,  $L_{Cpeak}$  can be processed  
Even if the frequency weighting characteristic is A,  $L_{Cpeak}$  is processed as C.

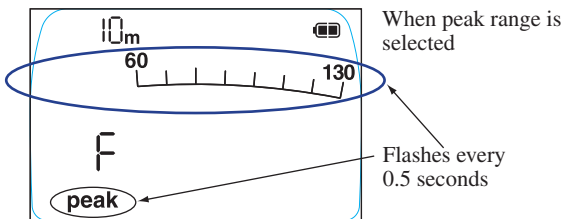

Press the A/C/CAL key to switch to the time weighting characteristic settings.

Press and hold the A/C/CAL key to return to the measurement screen.

## Setting time weighting characteristics

Press the START/STOP key or the MODE key to select the following settings.

F (fast), S (slow)

Press the A/C/CAL key to switch to the measurement time settings.

Press and hold the A/C/CAL key to return to the measurement screen.

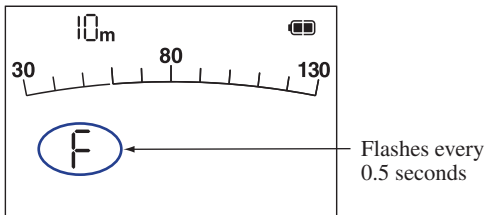

## Setting measurement time

Press the START/STOP key or the MODE key to select the following settings.

1 m (1 minute), 5 m (5 minutes), 10 m (10 minutes), 1 h (1 hour)

Press the A/C/CAL key to return to the measurement screen.

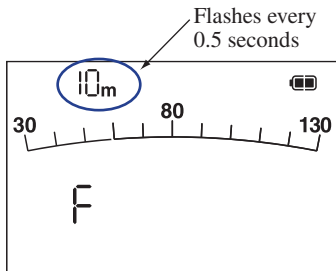

## Sleep mode

With the measurement screen being shown and no key is pressed for 10 minutes, the unit enters sleep mode and the sleep mode screen appears. Power consumption is 30% of normal in sleep mode.

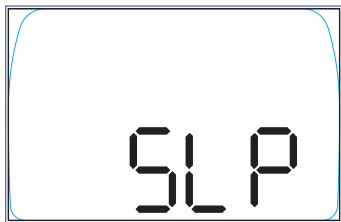

### Situations where the unit will not enter sleep mode

The unit will not enter sleep mode in the following situations, even if no key is pressed for 10 minutes.

If the processing screen, calibration screen, recall screen, or menu screen is displayed.

If a cable is connected to the external connector (any one of the three types).

### Waking the unit from sleep mode

Press any key in sleep mode to return to the measurement screen.

## Recalling stored data

In the measurement screen (frequency weighting characteristic C), press the A/C/CAL key three times to show the recall screen (see the state transition diagram on page 10). The most recent processing result is shown.

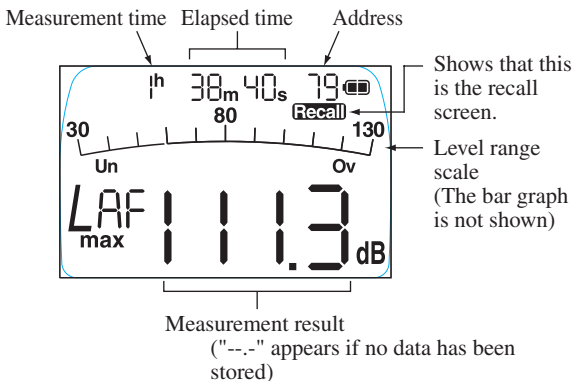

Press the START/STOP key or the MODE key to change the displayed data as follows ( $L_{Cpeak}$  appears only when peak range is selected).

Address n-1	$L_{eq} \Leftrightarrow L_{max} \Leftrightarrow L_E \Leftrightarrow (L_{Cpeak}) \Leftrightarrow$
Address n	$L_{eq} \Leftrightarrow L_{max} \Leftrightarrow L_E \Leftrightarrow (L_{Cpeak}) \Leftrightarrow$
Address n+1	$L_{eq} \Leftrightarrow L_{max} \Leftrightarrow L_E \Leftrightarrow (L_{Cpeak}) \Leftrightarrow$

Press and hold the START/STOP or the MODE key to move through the addresses faster.

---  $\Leftrightarrow$  Address n-1  $\Leftrightarrow$  Address n  $\Leftrightarrow$  Address n+1  $\Leftrightarrow$  ---

### To return to the measurement screen

Press the A/C/CAL key

## Clearing stored data

Press the A/C/CAL key for 3 or more seconds while the recall screen is shown and a screen asking you to confirm clearing of the data appears.

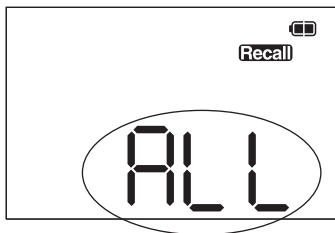

ALL and CLr flash alternately on the screen every 0.5 seconds.

Data clear confirmation screen

Press the START/STOP key and all stored data is cleared, then the recall screen appears again.

Press the A/C/CAL key to cancel the operation and return to the recall screen.

## Initializing

Power the unit on while pressing the START/STOP key and the settings in the unit are initialized.

### Initial setting values

Measurement time	10 m (10 minutes)
Time weighting characteristics	F (Fast)
Level range	Wide
Address	1



## Specifications

Applicable legislation	The Japan measurement law - Sound level meter JIS C 1509-1:2005 class 2 JIS C 1516:2014 class 2 IEC 61672-1:2013 class 2 CE Marking (EMC Directive 2004/108/EC, 2014/30/EU) WEEE Directive Chinese RoHS (units shipped to China only)
Measurement functions	
Processing type	Sound level $L_p$ Equivalent continuous sound level $L_{eq}$ Sound exposure level $L_E$ Maximum Sound level $L_{max}$ C weighting peak sound level $L_{Cpeak}$ (measurement possible only when peak range is selected)
Measurement times	1 minute, 5 minutes, 10 minutes, or 1 hour
Microphone	1/2-inch electret condenser microphone Model: UC-52 Sensitivity: -33 dB±3 dB (re.1 V/Pa)
Measurement level range	Wide range A weighting: 30 dB to 137 dB C weighting: 36 dB to 137 dB Peak range A weighting: 65 dB to 137 dB C weighting: 65 dB to 137 dB
Total range	30 dB to 137 dB (A weighting, 1 kHz)
Peak sound level measurement range	65 dB to 140 dB
Inherent noise level	Wide range A weighting: 24 dB or less C weighting: 30 dB or less Peak range A weighting: 59 dB or less C weighting: 59 dB or less

Measurement frequency range	20 Hz to 8 kHz
Reference frequency	1 kHz
Reference sound pressure level	94 dB
Frequency weighting characteristics	A and C
Time weighting characteristics	F (fast) and S (slow)
Level range	Wide range 30 to 130 dB Peak range* 65 to 130 dB * Peak range is used when measuring peak sound level.
RMS detecting circuit	Digital processing
Processing	Digital Sampling interval: 30.3 $\mu$ s ( $L_p$ , $L_{eq}$ , $L_{max}$ , $L_E$ , $L_{Cpeak}$ )
Calibration	Calibration frequency: 1 kHz Calibration sound pressure level: 94 dB The Japan measurement law: Electronic calibration using an internal electronic signal JIS, IEC: Acoustic calibration using NC-74
Windscreen	Conforms to JIS C 1509-1 Class 2 and IEC 61672-1 Class 2 even when the windscreen is attached
Display	TN positive display, reflective type
Numeric display	0.1 dB resolution
Bar graph	Scale range 100 dB, resolution 5 dB (display update cycle 0.1 s)
Warning indications	Over (overload): appears at 137.4 dB (at 1 kHz) Under (underload): appears at measurement lower limit, -0.6 dB
Battery indication	Battery charge is indicated in 3 stages
Storing processing results	Processing results stored in the internal memory when processing ends. Storing capacity: 199 pieces of data

	Stored data can be viewed in the recall screen. The stored data can also be sent to a computer through an optional USB adapter cable.
DC out connector	DC output: 3 V (full scale), 25 mV/dB Output impedance: 50 $\Omega$ Load impedance: 10 k $\Omega$ or more
AC monitor output connector	AC output: 1 V <sub>rms</sub> +600 mV <sub>rms</sub> (at 110 dB) -400 mV <sub>rms</sub> (Upper limit: 1.8 V <sub>rms</sub> ) Overload: +2 dB Output impedance: 600 $\Omega$ Load impedance: 10 k $\Omega$ or more Frequency weighting characteristics: Z weighting
USB connector	Use an optional USB adapter cable to send stored data to a computer.
Power requirements	2 size AAA (IEC R03, LR03) batteries Power consumption: Approx. 80 mA (when operating at 3 V) (Approx. 30% in sleep mode) Battery life (at normal temperature): Wide range Approx. 9 hours (using alkaline batteries) Approx. 3 hours (using manganese batteries) Peak range Approx. 7 hours (using alkaline batteries) Approx. 2 hours (using manganese batteries) Battery life will be reduced by 20% when a DC output cable is connected. Power consumption increases by approximately 20% during calibration.

Environmental conditions for operation	-10°C to 50°C, 10% to 90% RH (No condensation)	
Dimensions	Approx. 120 mm(H)×63 mm(W) ×23.5 mm(D)	
Weight	Approx. 105 g (including batteries)	
Supplied accessories		
Windscreen	WS-14	1
Hand strap	VM-63-017	1
Windscreen fall out prevention rubber	NL-27-014	1
Silicone cover	NL-27-026	1
Size AAA alkaline batteries		2
Instruction Manual		1
Inspection certificate		1
Optional equipments		
Sound calibrator	NC-74	
AC monitor output cable	CC-98A	
DC output cable	CC-98D	
USB adapter cable	CC-98S	



Left Side View

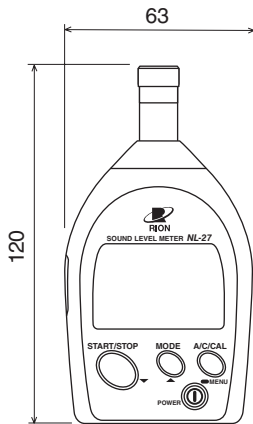

Front View



Right Side View

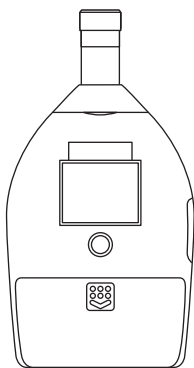

Rear View

Dimensional Drawings

Unit: mm

# Description for IEC 61672-1

Standard paragraph	Description	See also	Remark
<b>5</b>	<b>Performance specifications</b>		
<b>5.1</b>	<b>General</b>		
5.1.4	Configuration & normal mode of operation	9.2.1 b)	Configuration <ul style="list-style-type: none"> <li>• NL-27</li> <li>• WS-14</li> <li>• Windscreen fall out prevention rubber</li> <li>• Silicone cover (→ Attachments)</li> </ul> Normal mode of operation → Power on and off Unit powered
5.1.6	Models of microphone Appropriate procedures for use the sound level meter	9.2.1 c) 9.2.5 b)	UC-52 → Power on and off, Measurement, Calibration
5.1.7	Mounting of microphone	9.2.1 b)	→ Attachments
5.1.8	Identification of computer software		N/A
5.1.10	Description of frequency weightings that are provided	9.2.2 c)	A, C
5.1.12	Description of level ranges (@ A-weighted SPL @ 1 kHz ) Instruction manual of the level range controls and function. Recommendation for selecting the optimum level range.	9.2.2 h) 9.2.5 c)	30 dB to 137 dB  → Menu settings  → Menu settings

5.1.13	Reference SPL reference level range, Reference orientation, reference position of microphone.	9.2.5 a), 9.3 a), b), c)	94.0 dB Wide range Fig. 1 Reference incidence direction and reference point position
5.1.14	Operating of the hold facility and the means for clearing a display that is held.		→ Measurement: Maximum time- weighted sound level $L_{max}$ , C weighted peak sound level
5.1.15	Dummy microphone: Design goal and tolerance	9.3 g)	Capacitance of dummy microphone: 19 pF Tolerance: $\pm 3$ pF
5.1.16	Highest SPL and Peak-Peak input voltage without causing damage.	9.3 i)	150 dB 28 Vp-p
5.1.17	Characteristics of each independ- ent channel to be described		N/A
5.1.18	Initial time interval after switch- ing on power	9.2.5 e)	Less than 30 sec- onds.
<b>5.2</b>	<b>Adjustment to indicated levels</b>		
5.2.1	Model of sound calibrator(s)	9.2.4 a)	NC-74 (RION)
5.2.3	Procedure for calibration & ad- justment with sound calibrator	9.2.4 c)	→ Calibration: Acoustic calibra- tion with Sound Calibrator NC-74, 93.9 dB

5.2.4 5.2.5	Data for correction - with and without windscreen - for : - Deviation of average frequency response to uniform frequency response. - Case reflection and microphone diffraction Including values for expanded uncertainties. In 1/3 octave frequencies for 63 Hz to 1 kHz and 1/12 octave frequencies for 1 kHz to 16 kHz	9.2.4 d) 9.2.5 b)	Fig. 2 Frequency response of the microphone UC-52 (including the case reflection) Fig. 4 Influence of WS-14 on acoustic performance of NL-27
5.2.7	Adjustment data for sound calibrator or electrostatic actuator (for A-weighted sound levels)	9.3 d)	Tab. 2 Adjustment data for sound calibrator
<b>5.4</b>	<b>Frequency weightings</b>		
5.4.12	Frequency response & tolerances of optional frequency responses	9.2.2 c)	N/A
<b>5.5</b>	<b>Level linearity</b>		
5.5.9	A, C and Z weighted levels for the lower and upper limit of the linear operating range.	9.3 e)	Tab. 3 The lower and upper limits of the linear operating range
5.5.10	Starting point for the level linearity error	9.3 f)	Tab. 3 The lower and upper limits of the linear operating range
5.5.11	How to test level linearity if display range < linearity range	9.3 k)	N/A
<b>5.6</b>	<b>Self generated noise</b>		
5.6.1	Self-noise at the more sensitive ranges (including microphone)	9.2.5 o) 9.3 h)	Maximum value A: <24 dB C: <30 dB



5.6.3	Self-noise at the more sensitive ranges with dummy microphone	9.3 h)	Dummy microphone (19 pF) Maximum value Equal to 5.6.1 Typical value A: 19 dB C: 24 dB
<b>5.7</b>	<b>Time weighting F and S</b>		
5.7.1	Description of time weightings that are provided	9.2.2 d)	F, S
<b>5.10 - 5.11</b>	<b>Overload and Under-range indication</b>		
5.10.1	Operation & interpretation of overload indicators	9.2.5 k)	→ Measurement screen and processing screen
5.11.1	Operation & interpretation of under-range indicators		→ Measurement screen and processing screen
<b>5.12</b>	<b>Peak C sound level</b>		
5.12.1	Nominal range of LCpeak at for each level range	9.2.2 i)	→ Specifications
<b>5.14</b>	<b>Thresholds</b>		
5.14	Operation of user-selectable thresholds	9.2.5 l)	N/A
<b>5.15</b>	<b>Display</b>		
5.15.2	Description of the indication of displayed quantities	9.2.2 g)	→ Measurement screen and processing screen
5.15.3	Description of the display	9.2.2 g)	→ Measurement screen and processing screen
5.15.4	Description of the displayed quantities	9.2.2 a)	N/A
5.15.5	Statement of the display update rate	9.2.2 g)	1 second
5.15.6	Time interval for completion of the integration	9.2.5 f)	N/A
5.15.7	Description of method for transferring data to PC	9.2.5 m)	→ Attachments

<b>5.16</b>	<b>Analogue and digital outputs</b>		
5.16.1	Electric output connector (AC output)	9.2.5 p)	Frequency weighting: Z 1 Vrms <sup>+600 mVrms</sup> -400 mVrms (at 110 dB) Output range: 1.8 Vrms or less Output impedance: 600 Ω Load impedance: >10 kΩ
	Electric output connector (DC output)		Frequency weighting: A, C Output voltage: 3.0 V (at 130 dB), 25 mV/dB Output range: 0.5 to 3.2 V Output impedance: 50 Ω Load impedance: >10 kΩ
<b>5.17</b>	<b>Timing facilities</b>		
5.17.1	Procedure to preset the integration time & time of the day	9.2.5 g)	N/A
5.17.2	Statement of the minimum & maximum integration time	9.2.5 h)	N/A
<b>5.18</b>	<b>RF emissions and power supply disturbance</b>		
5.18.1	Length & type of interface cable and characteristics of connected devices	9.2.5 n)	AC monitor output cable CC-98A (2 m) DC output cable CC-98D (2 m) USB adapter cable CC-98S (2.5 m) All cables shielded

5.18.2	Operating mode or highest radio frequency emissions	9.3 n)	Operation mode: normal operation Connection pattern: USB adapter cable CC-98S (with ferrite cores)
<b>5.20</b>	<b>Power supply</b>		
5.20.2	Maximum and minimum power supply voltage	9.3 j	Maximum: 3.6 V Minimum: 1.8 V
5.20.3	Battery types & battery life	9.2.3 a)	Batteries
5.20.4	Operation from an external power supply	9.2.3 c)	N/A
5.20.5	Public power supply voltage	9.2.3 d)	N/A
<b>6</b>	<b>Environmental, electrostatic and radio frequency criteria</b>		
6.1.2	Time interval for needed to stabilize after environmental changes	9.3 l)	Temperature change: < 1 hour Humidity change: < 1 hour Static pressure change: < 5 minutes
6.2.2 (Note)	Measurement when static pressure is < 85 kPa		Calibration and measurement performed in this environment using Sound Calibrator NC-74
6.5.2	Degradation of functions by electrostatic discharge	9.2.7 b)	Measurement value affected temporarily by electrostatic discharge
6.6.1	Operating mode with least immunity to AC power frequency fields and RF fields	9.3 o)	Fig. 5 Operation mode: normal operation Connection pattern: USB adapter cable CC-98S (with ferrite cores)
6.6.4 (Note)	Field strength for conforming (in case > 10 V/m)	9.3 m)	N/A

<b>7</b>	<b>Provisions for use with auxiliary devices</b>		
7.1	Correction for use of microphone cable	9.2.6 b)	N/A
7.2	Effect of optional accessories (windscreen)	9.2.6 a)	Fig. 4 Influence of WS-14 on acoustic performance of NL-27
7.3	Statement of conformance with optional accessories (windscreen)		Compliant with IEC 61672-1 (JIS C 1509-1), with Windscreen WS-14 mounted
7.4	Operation of 1/1 - 1/3 octave band filters	9.2.6 c)	N/A
7.5	Details about connection & effects of auxiliary devices	9.2.6 d)	→ Attachments
<b>9</b>	<b>Instruction manual</b>		
<b>9.2.1</b>	<b>General</b>		
9.2.1 a)	Description of type, classification (X, Y, Z) and class		Group X, Class 2
9.2.1 b)	Overall configuration, Normal operation configuration (including windscreen)	5.1.4 5.1.7	Refer to 5.1.4 Refer to 5.1.7
9.2.1 c)	Models of microphones	5.1.6	Refer to 5.1.6
9.2.1 d)	Required microphone cable to conform		N/A
9.2.1 e)	Characteristics & operation each channel		N/A
<b>9.2.2</b>	<b>Design features</b>		
9.2.2 a)	Description of quantities which can be measured	5.15.4	time-weighted sound level, equivalent continuous sound level, maximum value of time-weighted sound level, sound exposure level, peak sound level

9.2.2 b)	Relative free-field response as function of incidence angle and frequency (detailed tabular description)		Directional Characteristics with Horizontal Direction (Fig. 6), Vertical Direction (Fig. 7)
9.2.2 c)	Description of the frequency weightings	5.1.10 5.4.12	Refer to 5.1.10 Refer to 5.4.12
9.2.2 d)	Description of the time weightings	5.7.1	Refer to 5.7.1
9.2.2 e)	Identification of the level ranges (A-weighted @ 1 kHz)	5.1.12	Refer to 5.1.12
9.2.2 f)	Operation of the level range control	5.1.12	Refer to 5.1.12
9.2.2 g)	Description of the display and update rates	5.15.2-3-4-5	Refer to 5.15.2-3-4-5
9.2.2 h)	Total range of A-weighted SPL (@ 1 kHz)	5.1.12	Refer to 5.1.12
9.2.2 i)	Nominal range of $L_{Cpeak}$ at for each level range	5.12.1	Refer to 5.12.1
9.2.2 j)	Computer software to operate the SLM	5.1.8	Refer to 5.1.8
9.2.2 k)	Design goals and tolerances for quantities which are not in the standard (T-weight 10 ms, $L_{A1eq}$ )		N/A
<b>9.2.3</b>	<b>Power supply</b>		
9.2.3 a)	Battery types & battery life	5.20.3	Refer to 5.20.3
9.2.3 b)	Description of the function of battery check		→ Batteries: Display
9.2.3 c)	Operation from an external power supply	5.20.4	Refer to 5.20.4
9.2.3 d)	Public power supply voltage	5.20.5	Refer to 5.20.5
<b>9.2.4</b>	<b>Adjustment to indicated levels</b>		
9.2.4 a)	Model of sound calibrator(s)	5.2.1	Refer to 5.2.1
9.2.4 b)	Calibration check frequency		1 kHz
9.2.4 c)	Procedure for calibration & adjustment with sound calibrator	5.2.3	Refer to 5.2.3

9.2.4 d)	Data for correction - with and without windscreen - for : - Deviation of average frequency response to uniform frequency response. - Case reflection and microphone diffraction Including values for expanded uncertainties. In 1/3 octave frequencies for 63 Hz to 1 kHz and 1/12 octave frequencies for 1 kHz to 16 kHz	5.2.4 - 5.2.5	Refer to 5.2.4 - 5.2.5
<b>9.2.5</b>	<b>Operating the sound level meter</b>		
9.2.5 a)	Reference direction	5.1.13	Refer to 5.1.13
9.2.5 b)	Procedure to measure sound, Influence of the instrument case and operator.	5.1.6 5.2.4 5.2.5	Refer to 5.1.6 Refer to 5.2.4 Refer to 5.2.5
9.2.5 c)	Recommendation for selecting optimum level range	5.1.12	Refer to 5.1.12
9.2.5 e)	Initial time interval after switching on power	5.1.18	Refer to 5.1.18
9.2.5 f)	Time interval for completion of the integration	5.15.6	Refer to 5.15.6
9.2.5 g)	Procedure to preset the integration time & time of the day	5.17.1	Refer to 5.17.1
9.2.5 h)	Statement of the minimum & maximum integration time	5.17.2	Refer to 5.17.2
9.2.5 i)	Operation of the "Hold" function		→ Measurement: Measurement of maximum time-weighted sound level

9.2.5 j)	Operation of the reset function or $L_{eq}$ , $L_E$ , $L_{peak}$ and overload		Measurement results (measurement values, overload indication, under-range indication) are reset when a new measurement is started. Time required for measurement initialization: < 1 second
9.2.5.k)	Operation & interpretation of overload indicators	5.10.1	Refer to 5.10.1
9.2.5 l)	Operation of user-selectable thresholds	5.14	Refer to 5.14
9.2.5 m)	Description of method for transferring data to PC	5.15.7	Refer to 5.15.7
9.2.5 n)	Length & type of interface cable and characteristics of connected devices	5.18.1	Refer to 5.18.1
9.2.5 o)	Self-noise at the more sensitive ranges (including microphone). Averaging time $\geq 30$ s.	5.6.1	Refer to 5.6.1
9.2.5 p)	Characteristics of AC and DC output	5.16.1	Refer to 5.16.1
<b>9.2.6</b>	<b>Accessories</b>		
9.2.6 a)	Effect of windscreen (directional response and frequency weighting)	7.2	Refer to 7.2
9.2.6 b)	Corrections for microphone cable	7.1	Refer to 7.1
9.2.6 c)	Use of bandpass filters	7.4	Refer to 7.4
9.2.6 d)	Connection of auxiliary devices	7.5	Refer to 7.5
<b>9.2.7</b>	<b>Influence of environmental conditions</b>		
9.2.7 a)	Components intended for operation in controlled environment		None
9.2.7 b)	Degradation of functions by electrostatic discharge	6.5.2	Refer to 6.5.2
9.2.7 c)	Statement for conformance to AC power frequency fields and RF fields		Statement of conforming to the basic statement (Tab. 1)

<b>9.3</b>	<b>Information for testing</b>		
9.3 a)	Reference sound pressure level	5.1.13	Refer to 5.1.13
9.3 b)	Reference level range	5.1.13	Refer to 5.1.13
9.3 c)	Microphone reference point	5.1.13	Refer to 5.1.13
9.3 d)	For A-weighted sound levels: Adjustment data for multi-frequency sound calibrator and/or electrostatic actuator	5.2.7	Refer to 5.2.7
9.3 e)	Nominal A-weighted sound levels at the upper and lower limits of the linear operating range on each level range. - For frequencies 31.5 Hz, 1, 4, 8 and 12.5 kHz	5.5.9	Refer to 5.5.9
9.3 f)	Starting point for the level linearity error - For frequencies 31.5 Hz, 1, 4, 8 and 12.5 kHz - At the reference level range	5.5.10	Refer to 5.5.10
9.3 g)	Dummy microphone: Design goal and tolerance	5.1.15	Refer to 5.1.15
9.3 h)	Self-noise at the more sensitive ranges with microphone and with dummy microphone	5.6.1 / 5.6.3	Refer to 5.6.1 / 5.6.3
9.3 i)	Highest SPL and Peak-Peak input voltage to accommodate	5.1.16	Refer to 5.1.16
9.3 j)	Maximum and minimum power supply voltage	5.20.2	Refer to 5.20.2
9.3 k)	How to test level linearity if display range < linearity range	5.5.11	Refer to 5.5.11
9.3 l)	Time interval for needed to stabilize after environmental changes	6.1.2	Refer to 6.1.2
9.3 m)	Field strength for conforming (in case > 10 V/m)	6.6.4	Refer to 6.6.4
9.3 n)	Operating mode or highest radio frequency emissions	5.18.2	Refer to 5.18.2
9.3 o)	Operating mode with least immunity to AC power frequency fields and RF fields	6.6.1	Refer to 6.6.1



## IEC61672-1 (JIS C 1509-1) Frequency Response

"Nominal frequency (Hz)"	"Exact frequency (Hz)"	"UC-52 Frequency Response (dB)"	"NL-27 Frequency Response (dB) case reflection"	"NL-27 Electrical Response (dB)"	"Total Response (dB)"	"Wind screen effect (dB)"	"Total Response (WS-14 combined) (dB)"	"Total expanded uncertainty"
63	63.10	0.0	0.0	-0.1	-0.1	0.0	-0.1	-0.1
80	79.43	0.0	0.0	-0.1	-0.1	0.0	-0.1	-0.1
100	100.0	0.0	0.0	-0.1	-0.1	0.0	-0.1	-0.1
125	125.9	0.0	0.0	0.0	0.0	0.0	0.0	0.0
160	158.5	0.0	0.0	0.1	0.1	0.0	0.1	0.1
200	199.5	0.0	0.0	0.1	0.1	0.0	0.1	0.1
250	251.2	0.0	0.0	0.1	0.1	0.0	0.1	0.1
315	316.2	0.0	0.0	0.1	0.1	0.0	0.1	0.1
400	398.1	0.0	0.0	0.1	0.1	0.0	0.1	0.1
500	501.2	0.0	0.0	0.0	0.0	0.0	0.0	0.0
630	631.0	0.0	0.0	0.1	0.1	0.0	0.1	0.1
800	794.3	0.0	0.0	0.0	0.0	0.0	0.0	0.0
1000	1000.0	0.0	0.2	0.0	0.2	-0.1	0.1	0.1
1060	1059.3	0.0	0.3	0.0	0.3	0.0	0.3	0.3
1120	1122.0	0.0	0.3	0.0	0.3	-0.1	0.2	0.2
1180	1188.5	0.0	0.3	0.0	0.3	0.0	0.3	0.3
1250	1258.9	0.0	0.3	0.0	0.3	-0.1	0.2	0.2
1320	1333.5	0.0	0.3	0.0	0.3	0.0	0.3	0.3
1400	1412.5	0.0	0.3	0.0	0.3	0.1	0.4	0.4
1500	1496.2	0.1	0.3	0.0	0.4	0.0	0.4	0.4
1600	1584.9	0.1	0.3	0.0	0.4	0.0	0.4	0.4
1700	1678.8	0.1	0.2	0.0	0.3	-0.1	0.2	0.2
1800	1778.3	0.1	-0.1	0.0	0.0	0.1	0.1	0.1
1900	1883.6	0.1	-0.1	0.0	0.0	0.1	0.1	0.1
2000	1995.3	0.2	-0.1	0.0	0.1	0.1	0.2	0.2
2120	2113.5	0.2	-0.1	0.0	0.1	0.2	0.3	0.3
2240	2238.7	0.2	0.0	0.0	0.2	0.2	0.4	0.4
2360	2371.4	0.2	0.0	0.0	0.2	0.1	0.3	0.3
2500	2511.9	0.3	-0.1	-0.1	0.1	0.2	0.3	0.3
2650	2660.7	0.3	-0.3	-0.1	-0.1	0.2	0.1	0.1
2800	2818.4	0.3	-0.6	-0.1	-0.4	0.2	-0.2	-0.2
3000	2985.4	0.4	-0.8	-0.1	-0.5	0.2	-0.3	-0.3
3150	3162.3	0.4	-0.8	-0.1	-0.5	0.2	-0.3	-0.3
3350	3349.7	0.4	-0.6	-0.1	-0.3	0.3	0.0	0.0
3550	3548.1	0.4	-0.4	-0.1	-0.1	0.4	0.3	0.3

"Nominal frequency (Hz)"	"Exact frequency (Hz)"	"UC-52 Frequency Response (dB)"	"NL-27 Frequency Response (dB) case reflection"	"NL-27 Electrical Response (dB)"	"Total Response (dB)"	"Wind screen effect (dB)"	"Total Response (WS-14 combined) (dB)"	"Total expanded uncertainty"
3750	3758.4	0.4	-0.4	-0.1	-0.1	0.3	0.2	0.2
4000	3981.1	0.4	-0.5	-0.1	-0.2	0.4	0.2	0.2
4250	4217.0	0.4	-0.6	-0.1	-0.3	0.4	0.1	0.1
4500	4466.8	0.4	-0.3	0.0	0.1	0.5	0.6	0.6
4750	4731.5	0.3	0.1	0.0	0.4	0.4	0.8	0.8
5000	5011.9	0.3	0.5	0.0	0.8	0.4	1.2	1.2
5300	5308.8	0.2	0.2	0.0	0.4	0.4	0.8	0.8
5600	5623.4	0.2	0.0	0.0	0.2	0.5	0.7	0.7
6000	5956.6	0.1	-0.1	0.0	0.0	0.5	0.5	0.5
6300	6309.6	0.0	0.0	0.0	0.0	0.5	0.5	0.5
6700	6683.4	-0.1	0.2	0.0	0.1	0.3	0.4	0.4
7100	7079.5	-0.2	0.3	0.0	0.1	0.3	0.4	0.4
7500	7498.9	-0.4	0.5	0.1	0.2	0.3	0.5	0.5
8000	7943.3	-0.5	0.1	0.1	-0.3	0.2	-0.1	-0.1

## Reference incidence direction and reference point position

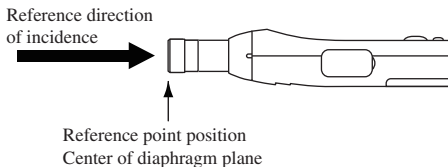

Fig. 1 Reference incidence direction and reference point position

## Frequency Response

The frequency response of a sound field microphone is expressed as the frequency response in the reference direction of incidence ( $0^\circ$ ).

The diagram below shows an example for the frequency response of the microphone UC-52.

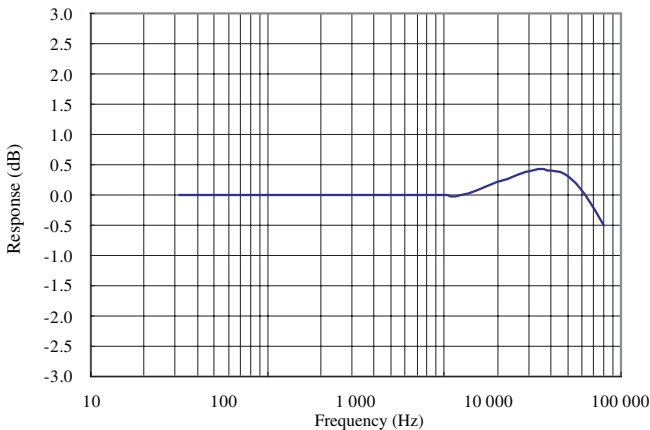

Fig. 2 Frequency response of the microphone UC-52

## Effect of Windscreen WS-14

The windscreen WS-14 reduces measurement errors due to wind noise.

The WS-14 characteristics are shown below.

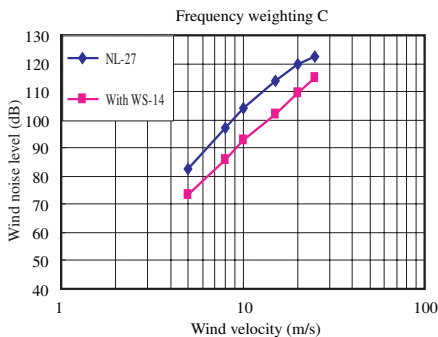
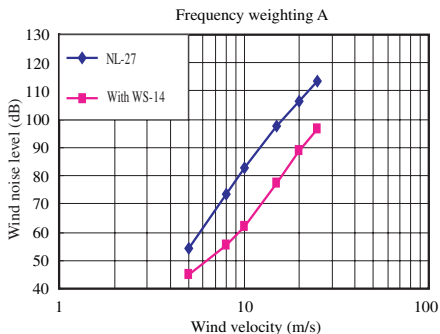

Fig. 3 Wind noise reduction effect

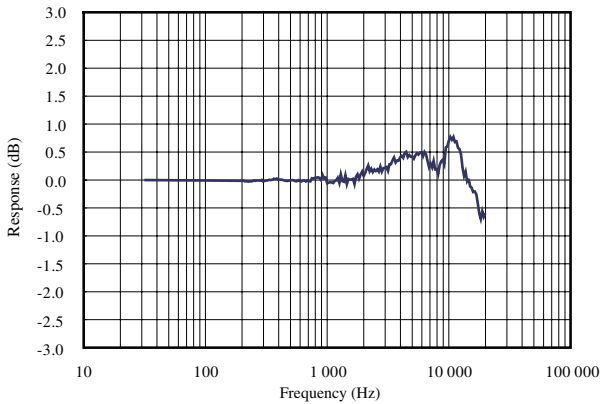
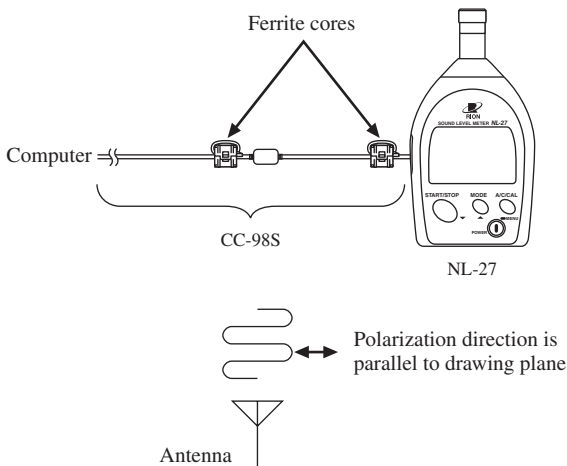

Fig. 4 Influence of WS-14 on acoustic performance of NL-27  
(Referenced to NL-27 characteristics)

## The greatest susceptibility configuration for radio frequency fields



Operation mode: normal operation

Connection pattern

- USB adapter cable (with ferrite cores) CC-98S 2.5 m

Fig. 5 The greatest susceptibility configuration for radio frequency fields

## Statement of conforming to the basic statement

Tab. 1 Statement of conforming to the basic statement

Immunity to AC power frequency fields	The specification of IEC 61672-1 Class 2 is satisfied
Immunity to RF fields	The specification of IEC 61672-1 Class 2 is satisfied
Emissions	The specification of IEC 61672-1 Class 2 is satisfied

## Adjustment data for sound calibrator

Tab. 2 Adjustment data for sound calibrator

Frequency (Hz)	Correction (dB)
31.5	0.0
63	0.0
125	0.0
250	0.0
500	0.0
1000	0.1
2000	0.3
4000	1.3
8000	3.2
12500	6.5
16000	6.7

## The lower and upper limits of the linear operating range

Tab. 3 The lower and upper limits of the linear operating range

A-weighting	Sound level (dB)			
	Frequency (Hz)	31.5	1 k	4 k
Upper	97.0	137.0	136.0	133.0
Start	54.0	94.0	94.0	94.0
Lower	30.0	30.0	30.0	30.0

C-weighting	Sound level (dB)			
	Frequency (Hz)	31.5	1 k	4 k
Upper	134.0	137.0	136.0	133.0
Start	94.0	94.0	94.0	94.0
Lower	36.0	36.0	36.0	36.0

## Directional Characteristics

The directional characteristics of NL-27 is a measure of its differing sensitivity for sound waves arriving from various angles. Since the electret condenser microphone used in the NL-27 is a pressure-sensitive type, it should be equally sensitive in all directions. However, refraction and cavity effects cause a certain microphone directional response at high frequencies.

Fig. 6 Directional Characteristics with Horizontal Direction

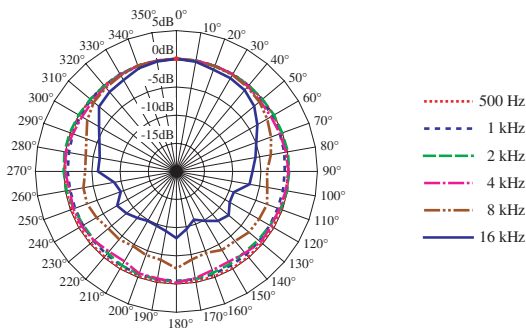
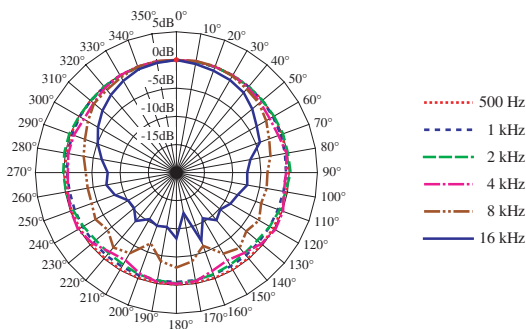

Fig. 7 Directional Characteristics with Vertical Direction





Tab. 4

Directional Characteristics with Horizontal Direction

An- gle	Frequency [Hz]					
	501	1000	1995	3981	7499	15849
0°	0	0	0	0	0	0
10°	-0.07	-0.01	-0.08	-0.03	-0.05	-0.23
20°	-0.07	-0.06	-0.07	-0.06	-0.15	-0.78
30°	-0.02	-0.07	-0.04	-0.13	-0.19	-0.87
40°	-0.04	-0.17	-0.04	-0.32	-0.46	-1.15
50°	-0.10	-0.28	-0.08	-0.57	-0.81	-1.98
60°	-0.09	-0.33	-0.01	-0.66	-1.38	-3.46
70°	-0.18	-0.46	-0.05	-0.46	-2.14	-4.94
80°	-0.19	-0.58	0.06	-0.26	-2.98	-5.75
90°	-0.22	-0.81	-0.01	-0.12	-3.94	-6.52
100°	-0.17	-0.80	-0.10	-0.32	-3.65	-6.83
110°	-0.19	-0.87	-0.38	-0.61	-2.87	-9.21
120°	-0.21	-0.86	-0.82	-0.55	-3.07	-9.07
130°	-0.19	-0.84	-1.04	-0.51	-3.22	-7.88
140°	-0.18	-0.75	-1.20	-1.09	-3.84	-8.54
150°	-0.16	-0.70	-1.03	-1.49	-3.89	-9.86
160°	-0.18	-0.64	-0.85	-1.37	-4.61	-10.87
170°	-0.16	-0.57	-0.59	-0.75	-4.15	-9.62
180°	-0.14	-0.56	-0.43	-0.24	-2.77	-8.17
190°	-0.17	-0.57	-0.53	-0.70	-4.09	-9.28
200°	-0.19	-0.57	-0.61	-0.71	-4.21	-9.72
210°	-0.14	-0.66	-0.73	-1.56	-4.68	-9.87
220°	-0.19	-0.77	-1.04	-1.42	-4.22	-9.25
230°	-0.17	-0.80	-0.97	-0.90	-4.28	-8.43
240°	-0.19	-0.87	-0.93	-0.56	-3.63	-7.85
250°	-0.18	-0.85	-0.64	-0.59	-3.14	-9.51
260°	-0.16	-0.88	-0.25	-0.76	-3.27	-8.79
270°	-0.19	-0.71	0.01	-0.26	-3.82	-6.08
280°	-0.14	-0.63	0.14	-0.09	-3.67	-6.17
290°	-0.11	-0.51	0.16	-0.40	-3.02	-5.49
300°	-0.11	-0.34	0.04	-0.67	-1.75	-4.15
310°	-0.08	-0.20	0.10	-0.58	-0.88	-2.09
320°	-0.08	-0.11	-0.15	-0.37	-0.60	-1.57
330°	-0.06	-0.08	-0.17	-0.24	-0.33	-1.29
340°	-0.03	-0.03	-0.08	-0.06	0.00	-0.54
350°	-0.03	0.00	-0.10	-0.07	-0.03	-0.20

Tab. 5

Directional Characteristics with Vertical Direction

An- gle	Frequency [Hz]					
	501	1000	1995	3981	7499	15849
0°	0	0	0	0	0	0
10°	-0.02	0.00	-0.05	0.06	0.10	-0.40
20°	-0.01	-0.03	-0.04	0.01	0.06	-0.74
30°	-0.02	-0.09	-0.08	-0.06	-0.21	-1.03
40°	-0.04	-0.11	-0.05	-0.27	-0.66	-1.46
50°	-0.08	-0.12	-0.07	-0.59	-0.86	-2.44
60°	-0.13	-0.22	0.00	-0.89	-1.63	-3.57
70°	-0.12	-0.31	0.12	-0.76	-2.52	-4.25
80°	-0.18	-0.47	0.06	-0.16	-3.09	-6.70
90°	-0.14	-0.57	0.27	-0.57	-3.85	-7.44
100°	-0.25	-0.73	-0.33	-0.65	-3.75	-7.25
110°	-0.21	-0.83	-0.57	0.11	-4.02	-8.42
120°	-0.18	-0.86	-0.86	0.20	-3.07	-8.93
130°	-0.18	-0.85	-1.28	-0.35	-3.81	-9.82
140°	-0.16	-0.81	-1.28	-1.36	-2.55	-8.96
150°	-0.13	-0.78	-1.06	-1.98	-3.38	-10.66
160°	-0.13	-0.70	-0.79	-1.42	-6.17	-7.11
170°	-0.14	-0.62	-0.52	-0.40	-3.96	-12.72
180°	-0.11	-0.57	-0.34	-0.28	-3.15	-8.29
190°	-0.12	-0.54	-0.55	-0.32	-4.02	-10.20
200°	-0.12	-0.59	-0.73	-0.95	-6.61	-9.93
210°	-0.16	-0.70	-1.11	-1.98	-3.50	-10.46
220°	-0.18	-0.76	-1.31	-1.60	-2.62	-8.78
230°	-0.20	-0.80	-1.33	-0.53	-4.17	-10.20
240°	-0.18	-0.78	-0.95	0.13	-3.46	-10.12
250°	-0.22	-0.81	-0.53	-0.07	-4.02	-8.36
260°	-0.22	-0.77	-0.11	-0.45	-4.01	-7.42
270°	-0.22	-0.62	0.06	-0.77	-3.93	-7.81
280°	-0.16	-0.47	0.18	-0.52	-3.29	-6.59
290°	-0.10	-0.35	0.22	-0.65	-2.72	-5.15
300°	-0.16	-0.21	-0.08	-1.06	-1.87	-3.95
310°	-0.14	-0.14	-0.17	-0.82	-0.95	-2.87
320°	-0.03	-0.15	-0.05	-0.35	-0.84	-1.96
330°	-0.04	-0.09	-0.12	-0.09	-0.45	-1.15
340°	-0.01	-0.04	-0.07	0.03	-0.01	-0.49
350°	-0.02	0.00	-0.10	0.06	0.10	-0.22

## Random incidence response

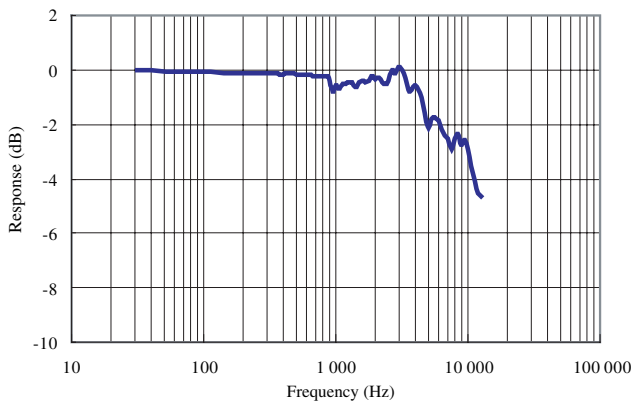

Fig. 8 Random incidence response



