

FLIR MODEL CM85

1000 A TRUE RMS POWER CLAMP METER

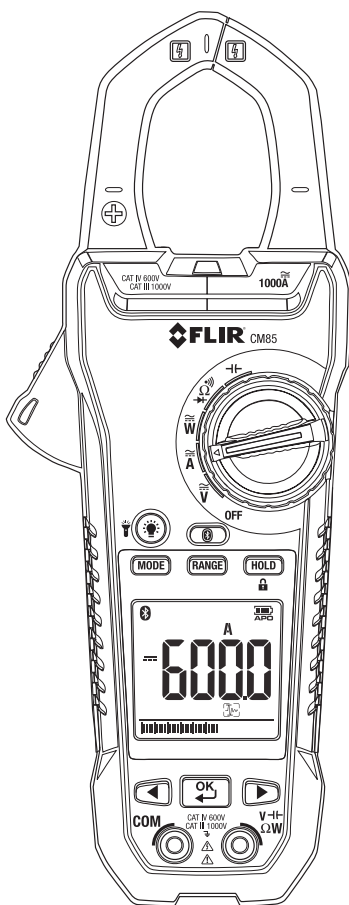

Table of Contents

| | |
|--------------------------------------|-----------|
| 1. DISCLAIMERS | 4 |
| 1.1 Copyright | 4 |
| 1.2 Quality Assurance | 4 |
| 1.3 Documentation | 4 |
| 1.4 Disposal of Electronic Waste | 4 |
| 2. SAFETY | 5 |
| 2.1 FCC Compliance | 6 |
| 2.2 Industry Canada Compliance | 7 |
| 3. INTRODUCTION | 8 |
| 3.1 Key Features | 8 |
| 4. METER DESCRIPTION | 9 |
| 4.1 Meter Parts | 9 |
| 4.2 Function Switch | 10 |
| 4.3 Function Buttons | 10 |
| 4.4 Display Icons and Indicators | 11 |
| 4.4.1 Out-of-range Warning | 12 |
| 5. OPERATION | 13 |
| 5.1 Powering the Meter | 13 |
| 5.1.1 Auto Power Off | 13 |
| 5.2 Auto/Manual Select Mode | 13 |
| 5.3 Auto/Manual Range Mode | 13 |
| 5.4 HOLD Mode | 14 |
| 5.4.1 Smart HOLD | 14 |
| 5.5 Silent Mode | 14 |
| 5.6 Voltage and Current Measurements | 14 |
| 5.6.1 Voltage Measurements | 14 |
| 5.6.2 Current Measurements | 14 |
| 5.6.3 Extended Functionality Modes | 15 |
| 5.6.3.1 Selecting Modes | 15 |
| 5.6.3.2 Peak Mode | 16 |
| 5.6.3.3 In-Rush Current Mode | 16 |
| 5.6.3.4 DC Zero Mode | 16 |

| | | |
|-----------|---|-----------|
| 5.6.3.5 | Frequency Mode | 16 |
| 5.6.3.6 | MIN/MAX/AVG Mode | 17 |
| 5.6.3.7 | Harmonic Distortion Mode | 17 |
| 5.6.3.8 | VFD Mode (low pass filter) | 17 |
| 5.7 | Non-Contact Voltage Detector | 17 |
| 5.8 | Power Measurements | 18 |
| 5.8.1 | Single Phase Power Measurements | 18 |
| 5.8.2 | Three-Phase Power Measurements | 19 |
| 5.8.2.1 | Three-Phase Three-Wire Balanced/Unbalanced | 19 |
| 5.8.2.2 | Three-Phase Four-Wire Balanced/Unbalanced | 20 |
| 5.8.3 | Phase Rotation | 21 |
| 5.9 | Resistance Measurements | 22 |
| 5.10 | Capacitance Measurements | 22 |
| 5.11 | Continuity Test | 23 |
| 5.12 | Diode Test | 23 |
| 5.13 | Streaming Measurement Data using Bluetooth | 24 |
| 5.13.1 | General | 24 |
| 5.13.2 | Procedures | 24 |
| 6. | MAINTENANCE | 25 |
| 6.1 | Cleaning and Storage | 25 |
| 6.2 | Battery Replacement | 25 |
| 6.2.1 | Disposal of Electronic Waste | 25 |
| 7. | SPECIFICATIONS | 26 |
| 7.1 | General specifications | 26 |
| 7.2 | Electrical specifications | 27 |
| 8. | TECHNICAL SUPPORT | 32 |
| 9. | WARRANTIES | 32 |
| 9.1 | FLIR Global Limited Lifetime Warranty | 32 |
| 9.2 | FLIR Test and Measurement Limited 2 Year Warranty | 33 |

1. Disclaimers

1.1 Copyright

© 2014, FLIR Systems, Inc. All rights reserved worldwide. No parts of the software including source code may be reproduced, transmitted, transcribed or translated into any language or computer language in any form or by any means, electronic, magnetic, optical, manual or otherwise, without the prior written permission of FLIR Systems.

The documentation must not, in whole or part, be copied, photocopied, reproduced, translated or transmitted to any electronic medium or machine readable form without prior consent, in writing, from FLIR Systems.

Names and marks appearing on the products herein are either registered trademarks or trademarks of FLIR Systems and/or its subsidiaries. All other trademarks, trade names or company names referenced herein are used for identification only and are the property of their respective owners.

1.2 Quality Assurance

The Quality Management System under which these products are developed and manufactured has been certified in accordance with the ISO 9001 standard.

FLIR Systems is committed to a policy of continuous development; therefore we reserve the right to make changes and improvements on any of the products without prior notice.

1.3 Documentation

To access the latest manuals and notifications, go to the Download tab at: <http://support.flir.com>. It only takes a few minutes to register online. In the download area you will also find the latest releases of manuals for our other products, as well as manuals for our historical and obsolete products.

1.4 Disposal of Electronic Waste



As with most electronic products, this equipment must be disposed of in an environmentally friendly way, and in accordance with existing regulations for electronic waste.



Please contact your FLIR Systems representative for more details.

2. Safety

Safety Notes

- Before operating the device, you must read, understand, and follow all instructions, dangers, warnings, cautions, and notes.
- FLIR Systems reserves the right to discontinue models, parts or accessories, and other items, or to change specifications at any time without prior notice.
- Remove the batteries if the device is not used for an extended period of time.





Warning Statements

- Do not operate the device if you do not have the correct knowledge. Formal qualifications and/or national legislation for the electrical inspections can apply. Incorrect operation of the device can cause damage, shock, injury or death to persons.
- Do not start the measuring procedure before you have set the function switch to the correct position. This can cause damage to the instrument and can cause injury to persons.
- Do not change to current or resistance when you measure the voltage. This can cause damage to the instrument and can cause injury to persons.
- Do not measure the current on a circuit when the voltage increases to more than 1000 V. This can cause damage to the instrument and can cause injury to persons.
- You must disconnect the test leads from the circuit that you did a test on before you change the range. If you do not do this, damage to the instrument and injury to persons can occur.
- Do not replace the batteries before you remove the test leads. This can cause damage to the instrument and can cause injury to persons.
- Do not use the device if the test leads and/or the device show signs of damage. Injury to persons can occur.
- Be careful when you do the measurements if the voltages are more than 25 VAC rms or 35 VDC. There is a risk of shock from these voltages. Injury to persons can occur.
- Do not do diode, resistance or continuity tests before you have removed the power from capacitors and other devices under test during a measurement. Injury to persons can occur.
- Do not use the device as a tool to identify live terminals. You must use the correct tools. Injury to persons can occur if you do not use the correct tools.
- Make sure that children cannot touch the device. The device contains dangerous objects and small parts that children can swallow. If a child swallows an object or a part, speak with a physician immediately. Injury to persons can occur.
- Do not let children play with the batteries and/or the packing material. These can be dangerous for children if they use them as toys.
- Do not touch expired or damaged batteries without gloves. Injury to persons can occur.
- Do not cause a short-circuit of the batteries. This can cause damage to the instrument and can cause injury to persons.
- Do not put the batteries into a fire. Injury to persons can occur.

Cautions

Do not use the device for a procedure that it is not made for. This can cause damage to the protection.

| | |
|---|--|
|  | This symbol, adjacent to another symbol or terminal, indicates that the user must refer to the manual for further information. |
|  | This symbol, adjacent to a terminal, indicates that, under normal use, hazardous voltages may be present. |
|  | Double insulation. |



UL listing is not an indication or a verification of the accuracy of the meter

2.1 FCC Compliance

This device complies with part 15 of the FCC Rules. Operation is subject to the following two conditions:

1. This device may not cause harmful interference.
2. This device must accept any interference received, including interference that may cause undesired operation.

This equipment has been tested and found to comply with the limits for a Class B digital device, pursuant to part 15 of the FCC Rules. These limits are designed to provide reasonable protection against harmful interference in a residential installation. This equipment generates, uses, and can radiate radio frequency energy and, if not installed and used in accordance with the instructions, may cause harmful interference to radio communications. However, there is no guarantee that interference will not occur in a particular installation. If this equipment does cause harmful interference to radio or television reception, which can be determined by turning the equipment off and on, the user is encouraged to try to correct the interference by one or more of the following measures:

1. Reorient or relocate the receiving antenna.
2. Increase the separation between the equipment and receiver.
3. Connect the equipment into an outlet on a circuit different from that to which the receiver is connected.
4. Consult the dealer or an experienced radio/TV technician for help.



CAUTION

Exposure to Radio Frequency Radiation.

To comply with FCC/IC RF exposure compliance requirements, a separation distance of at least 20 cm must be maintained between the antenna of this device and all persons. This device must not be co-located or operating in conjunction with any other antenna or transmitter.



WARNING

Changes or modifications not expressly approved by the party responsible for compliance could void the user's authority to operate the equipment.

2.2 Industry Canada Compliance

This device complies with part 15 of the FCC Rules. Operation is subject to the following two conditions:

This device complies with Industry Canada license-exempt RSS standard(s). Operation is subject to the following two conditions: (1) this device may not cause interference, and (2) this device must accept any interference, including interference that may cause undesired operation of the device.



CAUTION

Exposure to Radio Frequency Radiation.

To comply with RSS 102 RF exposure compliance requirements, for mobile configurations, a separation distance of at least 20 cm must be maintained between the antenna of this device and all persons. This device must not be co-located or operating in conjunction with any other antenna or transmitter.

3. Introduction

Thank you for selecting the FLIR CM85 1000A Power Clamp Meter. This device is shipped fully tested and calibrated and, with proper use, will provide years of reliable service.

3.1 Key Features

- 10 000-count digital display
- Large-scale display
- Analog bar graph
- True RMS reading in AC and AC+DC mode
- Work light
- Auto AC/DC 1000 A capability and selection
- Auto AC/DC 1000 V capability and selection
- Auto resistance/continuity/diode selection
- Power and power factor measurement
- Total harmonic distortion and 1 to 25 harmonics
- Phase rotation Indication
- 100 k Ω resistance capability
- Non-contact voltage detector
- Frequency measurement
- Capacitance capability
- Smart data hold
- Peak hold
- In-rush current
- DCA zero function
- Minimum/maximum and average hold
- VFD mode – Low-pass filter
- Auto power off
- Jaw opening 45 mm (1.77") for conductors up to 1.65" (42mm)
- 4' (1.2 m) drop-proof
- Convenient battery cover
- Safety Category Rating: CAT IV-600V, CAT III-1000V

4. Meter Description

4.1 Meter Parts

1. Clamp jaw
2. Jaw opening trigger
3. Function buttons, see section 4.3
Function buttons.
4. Navigation buttons
5. Non-contact voltage detector light
6. Function switch, see section 4.2
Function switch
7. LCD display
8. Probe terminals

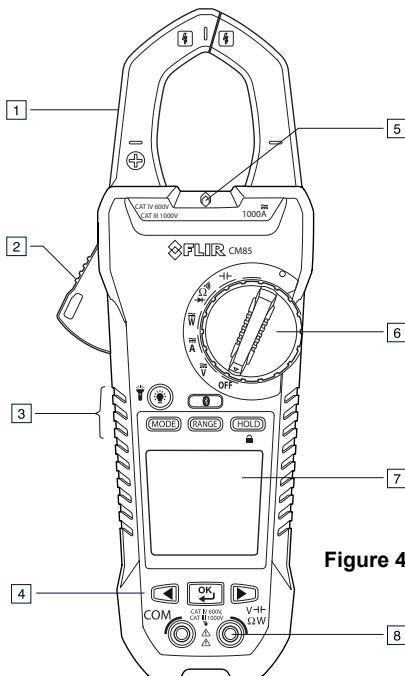

Figure 4.1 Front view

1. Work light
2. Battery compartment

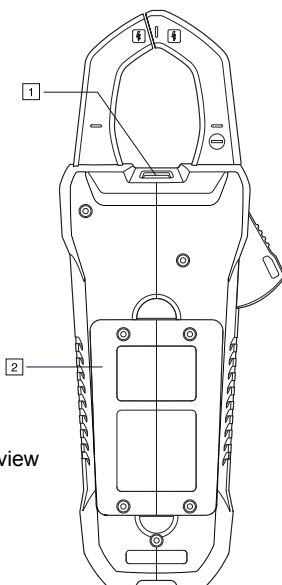











Figure 4.2 Rear view

4.2 Function Switch









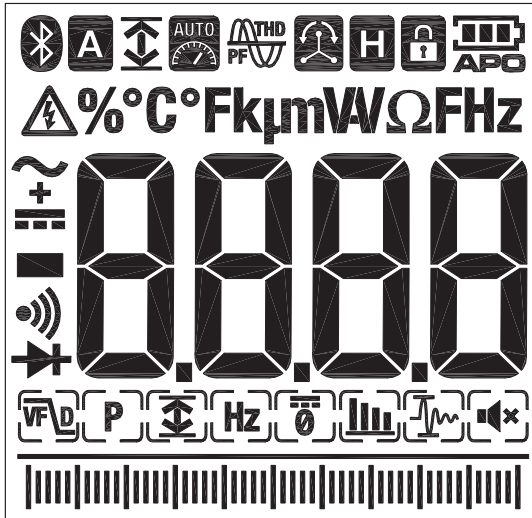

| | |
|---|---|
|  | The meter can measure capacitance through the probe inputs. |
|  | The meter can measure resistance, continuity, or diode polarity through the probe inputs. The type of measurement is selected by the MODE button. |
|  | The meter can measure power through the probe inputs and the clamp jaws. |
|  | The meter can measure current through the clamp jaws. |
|  | The meter can measure voltage through the probe inputs. |
| OFF | The meter is in full power-saving mode. |



















4.3 Function Buttons

| | |
|---|--|
|  | <ul style="list-style-type: none"> Use the button to select Auto select or Manual select mode, see section 5.2 <i>Auto/Manual select mode</i> In Manual select mode, press the button to select the operating mode |
|  | <ul style="list-style-type: none"> Use the button to select Auto range or Manual range mode, see section 5.3 <i>Auto/Manual range mode</i> In Manual range mode, press the button to change the range (scale) |
|  | <ul style="list-style-type: none"> Press the button to toggle between Normal and Hold modes, see section 5.4 <i>Hold mode</i> Holding the button down for 2 seconds enables/disables the key lock mode In Hold mode, the meter will beep continuously and the display will flash if the measured signal is larger than the display reading (for the V.A.W. function). |
|  | <ul style="list-style-type: none"> Press the button to enable/disable the display backlight. Press and hold the button for 2 seconds to enable/disable the work light. |
|  | Press the button to enable/disable METERLiNK® (Bluetooth) communication, see section 5.13 <i>Streaming measurement data using Bluetooth</i> |

4.4 Display Icons and Indicators



| | |
|---|---|
|  | <p>Indicates that METERLiNK® (Bluetooth) communication is active, see section 5.2 <i>Auto/Manual select mode</i>.</p> |
|  | <p>Indicates that the meter is in Auto select mode.</p> |
|  | <p>Indicates that the meter is displaying maximum reading values.</p> |
|  | <p>Indicates that the meter is displaying minimum reading values.</p> |
|  | <p>Indicates that the meter is displaying the average reading.</p> |
|  | <p>Indicates that the meter is displaying peak maximum values.</p> |
|  | <p>Indicates that the meter is displaying peak minimum values.</p> |
|  | <p>Indicates that the meter is in Auto range mode.</p> |
|  | <p>Indicates that the meter is in Power factor mode.</p> |
|  | <p>Indicates that the meter displays the total harmonic distortion.</p> |

| | |
|---|--|
|  | Indicates that the meter is in Phase rotation mode. |
|  | Indicates that the meter is in Hold mode. |
|  | Indicates the battery voltage status. |
| APO | Indicates that the auto power off function is enabled. |
|  | Indicates that the measured voltage is greater than 30 V DC or AC RMS. |
|  | Indicates that the meter is measuring AC current or voltage. |
|  | Indicates that the meter is measuring DC current or voltage. |
|  | Indicates that the meter is measuring AC+DC current or voltage. |
|  | Indicates that the continuity function is active. |
|  | Indicates that the diode test function is active. |
|  | VFD mode icon. |
|  | Peak mode icon. |
|  | Min/Max/Avg mode icon. |
|  | DC Zero mode icon. |
|  | Harmonic Distortion icon. |
|  | In-rush current mode icon. |
|  | Frequency mode icon. |
|  | Silent mode icon. |
|  | Lock mode icon. |

4.4.1 Out-of-range Warning

If the input is out-of-range, OL is displayed.

5. Operation

Note: Before operating the device, you must read, understand, and follow all instructions, dangers, warnings, cautions, and notes.

Note: When the meter is not in use, the function switch should be set to the OFF position.

Note: When connecting the probe leads to the device under test, connect the negative lead before connecting the positive lead. When removing the probe leads, remove the positive lead before removing the negative lead.

5.1 Powering the Meter

1. Set the function switch to any position to switch on the meter.
2. If the battery indicator  shows that the battery voltage is low or if the meter does not power on, replace the battery. See section 6.2 *Battery replacement*.

5.1.1 Auto Power Off

The meter enters sleep mode after 30 minutes of inactivity. The meter beeps three times 9 seconds before powering off. Press any button or turn the function switch to prevent the meter from powering off. The auto power off time-out is then reset. To disable auto power off (APO) press the MODE button while turning on the meter.

5.2 Auto/Manual Select Mode

In Auto select mode, the meter attempts to automatically select the proper operating mode (e.g., AC or DC measurement) based on the input signal. In Manual select mode, the desired operating mode is selected manually.

Auto select mode is the default mode of operation. When a new function is selected with the function switch, the starting mode is Auto select and the  indicator is displayed.

To enter Manual select mode, press the **MODE** button. To manually select the operating mode, press the **MODE** button repeatedly.

To enter Auto select mode, press and hold the **MODE** button until the  indicator is displayed.

5.3 Auto/Manual Range Mode

In Auto range mode, the meter automatically selects the most appropriate measurement scale. In Manual range mode, the desired range (scale) is set manually.

Auto range mode is the default mode of operation. When a new function is selected with the function switch, the starting mode is Auto range and the  indicator is displayed.

To enter Manual range mode, press the **RANGE** button. To change the range, press the **RANGE** button repeatedly until the desired range is displayed.

To enter Auto range mode, press and hold the **RANGE** button until the  indicator is displayed.

5.4 HOLD Mode

1. In Hold mode, the display freezes the last reading and continues to display this value.
2. Press the **HOLD** button to toggle between Normal and Hold modes. In Hold mode, the  indicator is displayed.

5.4.1 Smart HOLD

The meter will beep continuously and the display will flash if the measured signal is larger than the display reading (for the V.A.W. function).

5.5 Silent Mode

1. In Silent mode, the alert beeper is disabled. Silent mode does not affect the continuity beeper.
2. Use the navigation buttons to select the Silent mode icon ; see section 5.6.3.1.

5.6 Voltage and Current Measurements

Note: If the measured voltage is greater than 30 V DC or AC RMS, the  indicator is displayed.

5.6.1 Voltage Measurements

1. Set the function switch to the **V** position.
2. To manually select AC, DC, or AC+DC measurement, press the **MODE** button repeatedly. Refer to section 5.2 *Auto/Manual select mode*.
3. To manually select the measurement range (scale), press the **RANGE** button repeatedly. Refer to section 5.3 *Auto/Manual range mode*.
4. Insert the black probe lead into the negative COM terminal and the red probe lead into the positive V terminal.
5. Connect the probe leads in parallel to the part under test.
6. Read the voltage value on the display.

5.6.2 Current Measurements

 **WARNING** Do not measure the current on a circuit when the voltage increases to more than 1000 V. This can cause damage to the instrument and can cause injury to persons.

When measuring current using the clamp jaws, only one conductor should be enclosed by the jaws—refer to Figure 5.1.

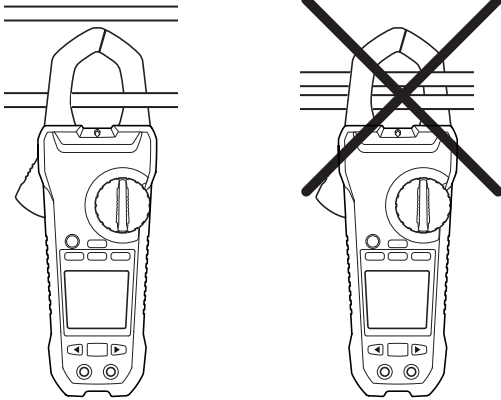

Figure 5.1 Correct and incorrect setup

1. Ensure that the probe leads are disconnected from the meter.
2. Set the function switch to the **A** position.
3. To manually select AC, DC, or AC+DC measurement, press the **MODE** button repeatedly. Refer to section 5.2 *Auto/Manual select mode*.
4. To manually select the measurement range (scale), press the **RANGE** button repeatedly. Refer to section 5.3 *Auto/Manual range mode*.
5. Press the trigger to open the clamp jaws. Fully enclose one conductor—refer to Figure 5.1. For optimum results, center the conductor in the jaws.
6. Read the current value on the display.

5.6.3 Extended Functionality Modes

In addition to the basic voltage and current measurements, the meter can be set to different modes for extended functionality.

5.6.3.1 Selecting Modes

The mode icons applicable for the selected measurement type are displayed in the lower part of the display. When a mode is enabled, the icon is framed.



Figure 5.2 Mode icons (AC voltage measurements): Peak mode and Silent mode are enabled

The navigation buttons are used to select a mode icon and to enable/disable a mode:

1. Use the **LEFT** and **RIGHT** navigation buttons to navigate to a mode icon. The currently selected icon will flash.
2. Press the **OK** button to enable/disable the selected (flashing) mode.

5.6.3.2 Peak Mode

In Peak mode, the meter captures and displays the positive and negative peak values, and updates only when a higher/lower value is registered. Peak mode is available when measuring AC current or voltage in Manual select mode.

Use the navigation buttons to select  and enable Peak mode.

Press the **OK** button to toggle between the display of Peak Max and Peak Min.

1. In Peak Max mode, the  indicator is displayed.

In Peak Min mode, the  indicator is displayed.

Press and hold the **OK** button for 2 seconds to disable Peak mode.

5.6.3.3 In-Rush Current Mode

In In-rush current mode, the meter displays the highest current reading in the first 100 ms after the trigger point. In-rush current mode is available when measuring AC current in Manual select mode.

Use the navigation buttons to select  and enable In-rush current mode.

Note: If the in-rush current under testing may be more than 100 A AC, manually set the range to 1000 A before activating the in-rush current, see section 5.3 *Auto/Manual range mode*.

5.6.3.4 DC Zero Mode

The DC zero feature removes offset values and improves the accuracy for DC current measurements. DC Zero mode is available when measuring DC or AC+DC current in Manual select mode.

1. Ensure that there is no conductor in the clamp jaws.
2. Use the navigation buttons to select  and enable DC Zero mode.





5.6.3.5 Frequency Mode

In Frequency mode, the meter measures and displays the frequency. Frequency mode is available when measuring AC current or voltage in Manual select mode.

Use the navigation buttons to select  and enable Frequency mode.

5.6.3.6 MIN/MAX/AVG Mode



In Min/Max/Avg mode, the meter captures and displays the minimum or maximum values and updates only when a higher/lower value is registered. The meter can also display the average of all values recorded from the beginning of Min/Max/Avg mode.

1. Use the navigation buttons to select  and enable Min/Max/Avg mode.
2. Press the **OK** button repeatedly to cycle through the minimum, maximum, and average reading displays. The corresponding icons are displayed: , , or .
3. Press and hold the **OK** button for 2 seconds to disable Min/Max/Avg mode.

5.6.3.7 Harmonic Distortion Mode

In Harmonic Distortion mode, the meter displays the distortion percentage value for the first 25 harmonics as well as the total harmonic distortion. Harmonic Distortion mode is available when measuring AC current or voltage in Manual select mode.

The harmonic distortion is expressed as $H_n = (\text{RMS of an individual harmonic } n) / (\text{RMS of the fundamentals}) \times 100\%$.

1. Use the navigation buttons to select  and enable Harmonic Distortion mode.
2. While in Harmonic Distortion mode, use the **LEFT** and **RIGHT** navigation buttons to navigate through the individual and total harmonic data. H01, H02, ..., Hn is displayed.
3. When the total harmonic distortion is displayed, the  indicator appears in the upper part of the display and 'thd' is shown in the main display.
4. Press the **OK** button to switch the display between Harmonic Order Indication mode and Percentage mode.
5. Press and hold the **OK** button for 2 seconds to disable Harmonic Distortion mode.

5.6.3.8 VFD Mode (low pass filter)

The VFD mode eliminates high frequency noise in voltage measurements by means of a low-pass filter. The VFD mode is designed for variable frequency drive (VFD) measurements. This mode is available for measurements of AC current or voltage.

1. Use the navigation buttons to select  and activate the VFD mode

5.7 Non-Contact Voltage Detector

Note: Test on a known live circuit before testing on an unfamiliar circuit.

1. Hold the clamp tips of the meter very close to the voltage source.
2. If voltage is present, the non-contact voltage alert lamp (see section 4.1 *Meter parts*) illuminates a red color.





If the non-contact voltage alert lamp is not illuminated, voltage could still be present.

5.8 Power Measurements

5.8.1 Single Phase Power Measurements

1. Set the function switch to the **W** position.
2. Insert the black probe lead into the negative COM terminal and the red probe lead into the positive W terminal.
3. Press the trigger to open the clamp jaws. Fully enclose one conductor—refer to Figure 5.1. For optimum results, center the conductor in the jaws.

Note: The + symbol on the jaw should be directed toward the power source

4. Connect the probe leads in parallel to the part under test.
5. Read the active power value on the display.
 - If the value is displayed without a sign, the power is flowing from the power source to the load.
 - If the value is displayed with a minus sign (–), the power is flowing from the power load to the source.
6. To measure and display the power factor, press the **MODE** button repeatedly until the  indicator is displayed.
7. Read the power factor value on the display.
 - If the value is displayed without a sign, the phase of the current signal is lagging behind the voltage signal (inductive load).
 - If the value is displayed with a minus sign (–), the phase of the current signal is leading the voltage signal (capacitive load).
8. To return to active power measurements, press the **MODE** button repeatedly until neither the  nor the  indicator is displayed.

If an overload occurs, the following is displayed:

OL. V: Voltage overload or both voltage and current overload.

OL. A: Current overload.

OL. kW: Active power overload.

5.8.2 Three-Phase Power Measurements

5.8.2.1 Three-Phase Three-Wire Balanced/Unbalanced

The power of a three-phase three-wire wye (star) configuration is measured in two steps, in accordance with Figure 5.3. The total power is the sum of the two measurements: $W = W_1 + W_2$.

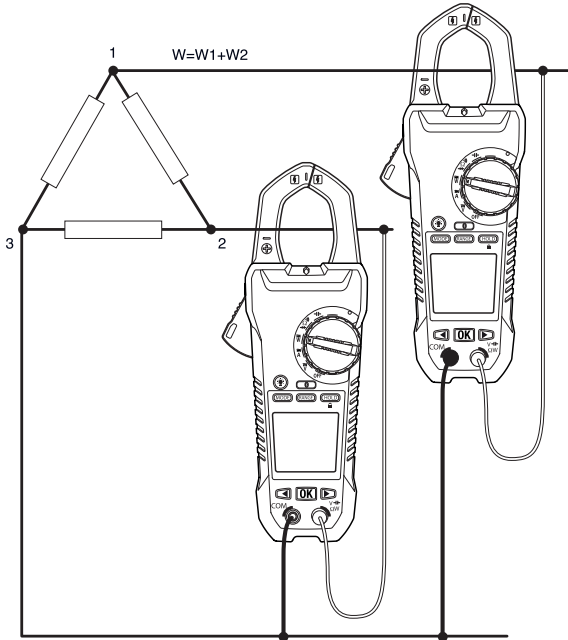



Figure 5.3 Three-phase three-wire measurements

1. Set the function switch to the **W** position.
2. Ensure that the meter is set to active power measurement. If the  or the  indicator is displayed, press the **MODE** button repeatedly until none of these indicators are displayed.
3. Take two measurements of the active power, in accordance with Figure 5.3.

5.8.2.2 Three-Phase Four-Wire Balanced/Unbalanced

The power of a three-phase four-wire configuration is measured in three steps, accordance with Figure 5.4. The total power is the sum of the three measurements: $W = W1 + W2 + W3$

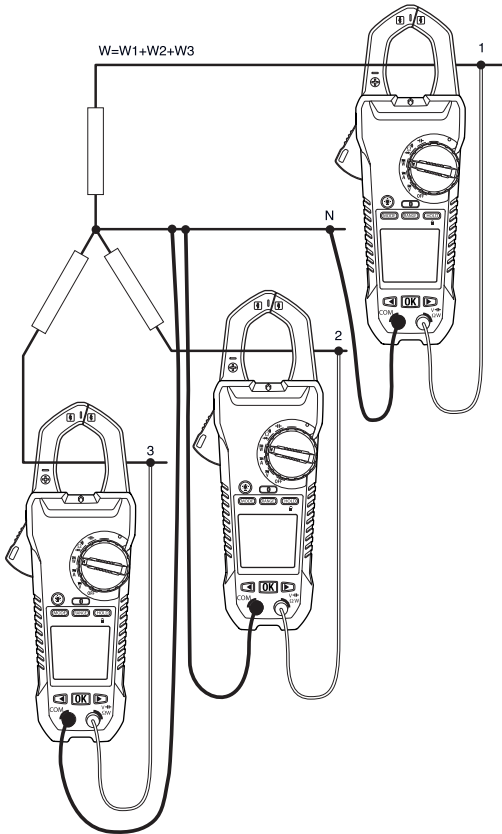



Figure 5.4 Three-phase four-wire measurements

1. Set the function switch to the **W** position.
2. Ensure that the meter is set to active power measurement. If the  or the  indicator is displayed, press the **MODE** button repeatedly until none of these indicators are displayed.
3. Take three measurements of the active power, in accordance with Figure 5.4.

5.8.3 Phase Rotation

With the meter set to Phase rotation mode, it is possible to determine the phase rotation for a three-wire system.

Note: The system frequency must be stable.

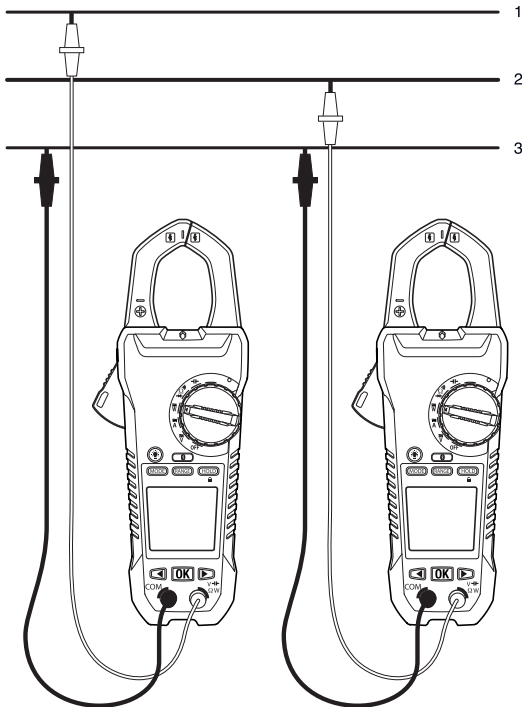





Figure 5.5 Phase rotation

1. Set the function switch to the **W** position.
2. Enter Phase rotation mode by pressing the **MODE** button repeatedly until the  indicator is displayed.
3. Connect the red test lead to the presumed phase line 1 and the black test lead to the presumed phase line 3.
4. One of the following results is displayed:
5. OL V flashes if the voltage is >1000 V.
6. Lo V flashes if the voltage is <30 V.
7. Out F flashes if the frequency is >65 Hz or <45 Hz.
8. If normal, L1 is displayed for about 3 seconds. Then L2 is displayed and the meter beeps twice.
9. Move the red test lead to the presumed phase line 2 immediately, before "L2" extinguishes from the display.

10. One of the following results is displayed:
11. 123 indicates clockwise or forward rotation, which means that the presumed phase line 1 is ahead of the presumed phase line 2.
12. 321 indicates counterclockwise or reversed rotation, which means that the presumed phase line 2 is ahead of the presumed phase line 1.
13. -- means that the meter is unable to determine the results.
14. Lo V means that users possibly removed the test leads before completing the testing procedure. To repeat the test, press the OK button again.

5.9 Resistance Measurements



Warning: Do not do diode, resistance or continuity tests before you have removed the power from capacitors and other devices under test during a measurement. Injury to persons can occur.

1. Set the function switch to the Ω position.
2. Ensure that the meter is set to resistance measurement. If the  or the  indicator is displayed, press the **MODE** button repeatedly until none of these indicators are displayed.
3. Insert the black probe lead into the negative COM terminal and the red probe lead into the positive Ω terminal.
4. Touch the tips of the probe across the circuit or component under test.
5. Read the resistance value on the display.

5.10 Capacitance Measurements

Warning: Do not do capacitance tests before you have removed the power the capacitor or other devices under test during a measurement. Injury to persons can occur.



Note: To protect the internal components, if a capacitor that is being tested has a charge, the meter will first discharge the cap and show diSC. After a complete discharge the meter will conduct a normal test. diSC may also be displayed if the incorrect input is provided (e.g., measuring voltage while in capacitance mode).

1. Set the function switch to the  position.
2. Insert the black probe lead into the negative COM terminal and the red probe lead into the positive  terminal.
3. Touch the tips of the probe across the part under test.
4. Read the capacitance value on the display.

Note: For very large capacitance values, it may take several seconds for the measurement to settle and the final reading to stabilize.



5.11 Continuity Test

Warning: Do not do diode, resistance or continuity tests before you have removed the power from capacitors and other devices under test during a measurement. Injury to persons can occur.

1. Set the function switch to the  position.
2. Insert the black probe lead into the negative COM terminal and the red probe lead into the positive Ω terminal.
3. Use the **MODE** button to select continuity measurement. The  indicator will be displayed.
4. Touch the tips of the probe across the circuit or component under test.
5. If the resistance is less than 30 Ω , the meter will beep.

5.12 Diode Test

Warning: Do not do diode, resistance or continuity tests before you have removed the power from capacitors and other devices under test during a measurement. Injury to persons can occur.

1. Set the function switch to the  position.
2. Insert the black probe lead into the negative COM terminal and the red probe lead into the positive Ω terminal.
3. Use the **MODE** button to select the diode test function. The  indicator will be displayed.
4. Touch the tips of the probe across the diode or semiconductor junction under test.
5. If the diode conducts at forward bias and opens at reverse bias, the meter displays the forward voltage (positive reading).
6. If the diode opens at forward bias and conducts at reverse bias, the meter displays the reverse voltage (negative reading).
7. If the diode conducts at both forward and reverse bias, the meter displays bAd.
8. If the reading is between 0.40 V and 0.80 V or between -0.40V and -0.80V , the component is good.

5.13 Streaming Measurement Data using Bluetooth

5.13.1 General

Some IR cameras from FLIR Systems support Bluetooth communication, and to those cameras you can stream measurement data from the meter. The data is then merged into the result table in the IR image.

Streaming measurement data is a convenient way to add important information to an IR image. For example, when identifying an overheated cable connection, you may want to know the current in that cable.

The Bluetooth range is 10m (32ft) maximum.

5.13.2 Procedures

1. Pair the IR camera with the instrument. Refer to the camera manual for information on how to pair Bluetooth devices.
2. Turn on the camera.
3. Turn on the meter.
4. Press the  button on the meter to enable Bluetooth.
5. Choose the variable that you want to use (voltage, current, resistance, etc.). Results from the meter will now automatically be displayed in the result table in the top left corner of the IR camera screen.

6. Maintenance

6.1 Cleaning and Storage

Clean the meter with a damp cloth and mild detergent; do not use abrasives or solvents.

If the meter is not to be used for an extended period, remove the batteries and store them separately.

6.2 Battery Replacement

1. To avoid electrical shock, disconnect the meter if connected to a circuit, remove the probe/thermocouple leads from the terminals, and set the function switch to the OFF position before attempting to replace the batteries.
2. Unscrew and remove the battery compartment cover.
3. Replace the six standard AAA batteries, observing correct polarity.
4. Secure the battery compartment cover.

6.2.1 Disposal of Electronic Waste

As with most electronic products, this equipment must be disposed of in an environmentally friendly way, and in accordance with existing regulations for electronic waste.

Please contact your FLIR Systems representative for more details.

7. Specifications



7.1 General specifications

Display count: 10 000 or 4000.

Measuring rate: 3 times per second

Over-range indication: OL or –OL.

Auto power off: Approx. 30 minutes.

Low battery indicator:  is displayed. Replace battery when the indicator  appears in the display.

Power requirement: 6 × 1.5 V AAA alkaline batteries.

Battery life: Approx. 50 hours with alkaline batteries (backlight, work light, and Bluetooth are off).

Environmental conditions: Indoor use.

Calibration: 1 year calibration cycle.

Operating temperatures:

32 to 50 °F (0 to 10 °C) (non-condensing)

50 to 86 °F (10 to 30 °C) (≤ 80% RH)

86 to 104 °F (30 to 40 °C) (≤ 75% RH)

104 to 122 °F (40 to 50 °C) (≤ 45%RH)

Storage temperature:

14 to 122 °F (–10 to 50 °C).

0–80% RH (batteries not fitted).

Dimensions: (H × W × L): 1.9" × 3.9" × 10.3" (49 mm × 100 mm × 262 mm).

Weight: 1.29 lbs. (0.59 kg), including batteries.

Bluetooth range: 32 ft. (10 m) maximum.

Temperature coefficient: 0.2 × (specified accuracy)/°C, < 64.4°F (18 °C), >82.4°F (28 °C).

Over-voltage category: IEC 61010-1 CAT IV-600 V, CAT III-1000 V, IEC 61010-2-033.

| CAT | Application field |
|-----|---|
| I | Circuits not connected to mains |
| II | Circuits directly connected to a low-voltage installation |
| III | Building installation |
| IV | Source of the low-voltage installation |

Operating altitude: 6562' (2000 m)

Jaw opening: 1.77" (45 mm).

Conductor size: 1.65" (42 mm).

Pollution degree: 2.

EMC: EN 61326-1.

7.2 Electrical specifications

Accuracy is \pm (% reading + number of digits (dgt)) at 73.4 °F \pm 9 °F (23°C \pm 5 °C), <80% RH.

Table 7.1 Voltage (TRMS)

| Function | Range | Accuracy (of reading) 1 |
|------------|--------------|--------------------------------|
| DCV | 99.99 V | $\pm(0.7\% + 2 \text{ dgt})$ |
| | 999.9 V | |
| ACV | 0.05–99.99 V | $\pm(1.0\% + 5 \text{ dgt})$ |
| | 999.9 V | 50–500 Hz |
| VFD ACV | 0.05–99.99 V | 50–60 Hz \pm (1% + 5 dgt) |
| | 999.9 V | |

1. DCV <1000 dgt, add 6 dgt to the accuracy. ACV <1000 dgt, add 3 dgt to the accuracy.

Overload protection: 1000 Vrms.

Input impedance: 3.5 M Ω //, <100 pF.

AC conversion type: AC coupled, true RMS responding, calibrated to the RMS value of a sine wave input. Accuracies are given for sine waves at full scale and non-sine waves below half scale. For non-sine waves (50/60 Hz), add the following crest factor corrections:

For a crest factor of 1.4–2.0, add 1.0% to the accuracy.

For a crest factor of 2.0–2.5, add 2.5% to the accuracy.

For a crest factor of 2.5–3.0, add 4.0% to the accuracy.

CF:

3 @ 460 V, 460 A.

2 @ 690 V, 690 A.

AC+DC Vrms accuracy: Same as ACV specification + DCV specification.

Table 7.2 Current (TRMS)

| Function | Range | Accuracy |
|------------|--------------|--|
| DCA | 99.99 A | $\pm(2\% + 0.5 \text{ A})$ |
| | 999.9 A | $\pm(2\% + 5 \text{ dgt})^*$ |
| ACA | 0.10–99.99 A | $50\text{--}60 \text{ Hz} \pm (2\% + 5 \text{ dgt})^*$ |
| | 999.9 A | $>60\text{--}400 \text{ Hz} \pm (2.5\% + 5 \text{ dgt})^*$ |
| VFD ACA | 0.10–99.99 A | $50\text{--}60 \text{ Hz} \pm (2\% + 5 \text{ dgt})^*$ |
| | 999.9 A | |

* For measured values <1000 dgt, add 5 dgt to the accuracy.

Overload protection: 1000 Arms.

Position error: $\pm 1\%$ of reading.

AC conversion type and additional accuracy is same as for the AC voltage.

AC+DC Arms accuracy: Same as ACA specification + DCA specification. The DCA is affected by the temperature and the residual magnetism. Use the DCA zero function to compensate.

Table 7.3 Peak hold: peak maximum/peak minimum (AC only, Non TRMS)

| Function | Range | Accuracy |
|----------|---------|-------------------------------|
| ACV | 140.0 V | $\pm(3.0\% + 15 \text{ dgt})$ |
| | 1400 V | |
| ACA | 140.0 A | $\pm(3.5\% + 15 \text{ dgt})$ |
| | 1400 A | |

Overload protection: 1000 Vrms , 1000 Arms

Accuracy defined for sine waves, ACV > 5 Vrms/ACA \geq 5 Arms, frequency 50–400 Hz. Suitable for repetitive events.

Table 7.4 Frequency

| Function | Range | Accuracy |
|-----------|-----------------|-----------------|
| Frequency | 20.00–99.99 Hz | ±(0.5% + 3 dgt) |
| | 20.0–999.9 Hz | |
| | 0.020–9.999 kHz | |

Overload protection: 1000 Vrms, 1000 Arms.

Sensitivity:

10–100 Vrms for AC 100 V range.

10–100 Arms for AC 100 A range (>400 Hz unspecified).

100–1000 Vrms for AC 1000 V range.

100–1000 Arms for AC 1000 A range (>400 Hz unspecified).

The reading will be 0.0 for signals below 10.0 Hz.

Table 7.5 Total harmonic distortion

| Function | Range | Accuracy |
|----------|-------|------------------|
| ACA/ACV | 99.9% | ±(3.0% + 10 dgt) |

Table 7.6 Harmonic distortion measurement

| Harmonic order | Range | Accuracy |
|----------------|-------|-----------------|
| H01–H12 | 99.9% | ±(5% + 10 dgt) |
| H13–H25 | | ±(10% + 10 dgt) |

Overload protection: 1000 Vrms, 1000 Arms

If ACV < 10 Vrms or ACA < 10 Arms, rdy is displayed.

If the fundamental frequency is outside the range 45–65Hz, out.F is displayed.

Table 7.7 Inrush current

| Function | Range | Accuracy |
|----------|---------|----------------|
| ACA | 99.99 A | ±(3% + 0.3 A) |
| | 999.9 A | ±(3% + 5 dgt)* |

* For measured values <1000 dgt, add 5 dgt to the accuracy.

Overload protection: 1000 Vrms, 1000 Arms.

Accuracy is defined for sine waves, ACA ≥ 10 Arms, freq. 50/60 Hz. Integration time approx. 100 ms.

Table 7.8 Active power: watts (DC/AC)

| Function | Range 1 | Accuracy |
|----------|--------------------------|------------------------------|
| DCW | 9.999 kW (10 V, 5 A min) | $\pm(3\% + 0.05 \text{ kW})$ |
| | 99.99 kW (10 V, 5 A min) | $\pm(3\% + 0.5 \text{ kW})$ |
| | 999.9 kW (10 V, 5 A min) | $\pm(3\% + 10 \text{ dgt})$ |
| ACW | 9.999 kW (10 V, 5 A min) | $\pm(3\% + 10 \text{ dgt})$ |
| | 99.99 kW (10 V, 5 A min) | |
| | 999.9 kW (10 V, 5 A min) | |

1. The range is determined by the V/A range (9.999 kW: 100 V, 100 A; 99.99 kW: 1000 V, 100 A, or 100 V, 1000 A; 999.9 kW: 1000 V, 1000 A).

Overload protection: 1000 Vrms, 1000 Arms.

Accuracy defined for:

ACW:

Sine waves, ACV \geq

10 Vrms, ACA \geq 5 Arms.

Frequency 50–60 Hz, PF = 1.00.

DCW: DCV \geq 10 V, DCA \geq 5 A.

Table 7.9 Power factor

| Function | Range | Accuracy |
|----------|------------------------|---------------------------------|
| PF | -1.00 to 0.00 to +1.00 | $\pm 3^\circ \pm 1 \text{ dgt}$ |

Overload protection: 1000 Vrms, 1000 Arms.

Table 7.10 Resistance and continuity and diode

| Function | Range | Accuracy |
|------------|------------------|------------------------------|
| Resistance | 999.9 Ω | $\pm(1.0\% + 5 \text{ dgt})$ |
| | 9.999 k Ω | $\pm(1.0\% + 3 \text{ dgt})$ |
| | 99.99 k Ω | |
| Continuity | 999.9 Ω | $\pm(1.0\% + 5 \text{ dgt})$ |
| Diode | 0.40–0.80 V | $\pm 0.1V$ |

Overload protection: 1000 Vrms.

Maximum test current: Approx. 0.5 mA.

Maximum open circuit voltage for Ω : Approx. 2.4 V.

Maximum open circuit voltage for diode: Approx. ± 1.6 V.

Continuity threshold:

<30 Ω beep on.

>100 Ω beep off.

Continuity indicator: 2 kHz tone buzzer.

Continuity response time: <100 ms.

Table 7.11 Capacitance

| Function | Range | Accuracy |
|-------------|---------------------|------------------------------|
| Capacitance | 3.999 μF | $\pm(1.9\% + 8 \text{ dgt})$ |
| | 39.99 μF | |
| | 399.9 μF | |
| | 3.999 mF | |

Overload protection: 1000 Vrms.

8. Technical Support

| | |
|---------------------------|---|
| Website | http://www.flir.com/test |
| Technical Support Website | http://support.flir.com |
| Technical support Email | T&MSupport@flir.com |
| Repairs Email | Repair@flir.com |
| Telephone number | +1 855-499-3662 (toll-free) |

9. Warranties

9.1 FLIR Global Limited Lifetime Warranty

A qualifying FLIR Test and Measurement product (the "Product") purchased either directly from FLIR Commercial Systems Inc and affiliates (FLIR) or from an authorized FLIR distributor or reseller that Purchaser registers on-line with FLIR is eligible for coverage under FLIR's Limited Lifetime Warranty, subject to the terms and conditions in this document. This warranty only applies to purchases of Qualifying Products (see below) purchased and manufactured after April 1, 2013.

PLEASE READ THIS DOCUMENT CAREFULLY; IT CONTAINS IMPORTANT INFORMATION ABOUT THE PRODUCTS THAT QUALIFY FOR COVERAGE UNDER THE LIMITED LIFETIME WARRANTY, PURCHASER'S OBLIGATIONS, HOW TO ACTIVATE THE WARRANTY, WARRANTY COVERAGE, AND OTHER IMPORTANT TERMS, CONDITIONS, EXCLUSIONS AND DISCLAIMERS.

1. **PRODUCT REGISTRATION.** To qualify for FLIR's Limited Lifetime Warranty, Purchaser must fully register the Product directly with FLIR on-line at <http://www.flir.com> within Sixty (60) DAYS of the date the Product was purchased by the first retail customer (the "Purchase Date"). Qualifying PRODUCTS THAT ARE NOT REGISTERED ON-LINE WITHIN SIXTY (60) DAYS OF THE PURCHASE DATE WILL HAVE A LIMITED ONE YEAR WARRANTY FROM DATE OF PURCHASE.

2. **QUALIFYING PRODUCTS.** Upon registration, Test and Measurement products that qualify for coverage under FLIR's Limited Lifetime Warranty are: MR7x, CM7x, CM8x, DMxx, VP5x not including accessories which may have their own warranty.

3. **WARRANTY PERIODS.** For purposes of the The Limited Lifetime Warranty, Lifetime is defined as seven years (7) after the product is no longer manufactured, or ten years (10) from date of purchase, whichever is greater. This Warranty is only applicable to the original owner of the Products.

Any Product that is repaired or replaced under warranty is covered under this Limited Lifetime Warranty for one hundred eighty days (180) days from the date of return shipment by FLIR or for the remaining duration of the applicable Warranty Period, whichever is longer.

4. **LIMITED WARRANTY.** In accordance with the terms and conditions of this Limited Lifetime Warranty, and except as excluded or disclaimed in this document, FLIR warrants, from the Purchase Date, that all fully registered Products will conform to FLIR's published Product specifications and be free from defects in materials and workmanship during the applicable Warranty Period. PURCHASER'S SOLE AND EXCLUSIVE REMEDY UNDER THIS WARRANTY, AT FLIR'S SOLE DISCRETION, IS THE REPAIR OR REPLACEMENT OF DEFECTIVE PRODUCTS IN A MANNER, AND BY A SERVICE CENTER, AUTHORIZED BY FLIR. IF THIS REMEDY IS ADJUDICATED TO BE INSUFFICIENT, FLIR SHALL REFUND PURCHASER'S PAID PURCHASE PRICE AND HAVE NO OTHER OBLIGATION OR LIABILITY TO BUYER WHATSOEVER.

5. **WARRANTY EXCLUSIONS AND DISCLAIMERS.** FLIR MAKES NO OTHER WARRANTY OF ANY KIND WITH RESPECT TO THE PRODUCTS. ALL OTHER WARRANTIES, EXPRESS OR IMPLIED, INCLUDING BUT NOT LIMITED TO IMPLIED WARRANTIES OF MERCHANTABILITY, FITNESS FOR A PARTICULAR PURPOSE (EVEN IF PURCHASER HAS NOTIFIED FLIR OF ITS INTENDED USE FOR THE PRODUCTS), AND NON-INFRINGEMENT ARE EXPRESSLY EXCLUDED FROM THIS AGREEMENT.

THIS WARRANTY EXPRESSLY EXCLUDES ROUTINE PRODUCT MAINTENANCE, SOFTWARE UPDATES, AND REPLACEMENT OF

MANUALS, FUSES, OR DISPOSABLE BATTERIES. FLIR FURTHER EXPRESSLY DISCLAIMS ANY WARRANTY COVERAGE WHERE THE ALLEGED NONCONFORMITY IS DUE TO NORMAL WEAR AND TEAR, OTHER ALTERATION, MODIFICATION, REPAIR, ATTEMPTED REPAIR, IMPROPER USE, IMPROPER MAINTENANCE, NEGLIGENCE, ABUSE, IMPROPER STORAGE, FAILURE TO FOLLOW ANY PRODUCT INSTRUCTIONS, DAMAGE (WHETHER CAUSED BY ACCIDENT OR OTHERWISE), OR ANY OTHER IMPROPER CARE OR HANDLING OF THE PRODUCTS CAUSED BY ANYONE OTHER THAN FLIR OR FLIR'S EXPRESSLY AUTHORIZED DESIGNEE.

THIS DOCUMENT CONTAINS THE ENTIRE WARRANTY AGREEMENT BETWEEN PURCHASER AND FLIR AND SUPERSEDES ALL PRIOR WARRANTY NEGOTIATIONS, AGREEMENTS, PROMISES AND UNDERSTANDINGS BETWEEN PURCHASER AND FLIR. THIS WARRANTY MAY NOT BE ALTERED WITHOUT THE EXPRESS WRITTEN CONSENT OF FLIR.

6. WARRANTY RETURN, REPAIR AND REPLACEMENT. To be eligible for warranty repair or replacement, Purchaser must notify FLIR within thirty (30) days of discovering of any apparent defect in materials or workmanship. Before Purchaser may return a Product for warranty service or repair, Purchaser must first obtain a returned material authorization (RMA) number from FLIR. To obtain the RMA number Owner must provide an original proof of purchase. For additional information, to notify FLIR of an apparent defect in materials or workmanship, or to request an RMA number, visit <http://www.flir.com>. Purchaser is solely responsible for complying with all RMA instructions provided by FLIR including but not limited to adequately packaging the Product for shipment to FLIR and for all packaging and shipping costs. FLIR will pay for returning to Purchaser any Product that FLIR repairs or replaces under warranty.

FLIR reserves the right to determine, in its sole discretion, whether a returned Product is covered under Warranty. If FLIR determines that any returned Product is not covered under Warranty or is otherwise excluded from Warranty coverage, FLIR may charge Purchaser a reasonable handling fee and return the Product to Purchaser, at Purchaser's expense, or offer Purchaser the option of handling the Product as a non-warranty return.

7. NON-WARRANTY RETURN. Purchaser may request that FLIR evaluate and service or repair a Product not covered under warranty, which FLIR may agree to do in its sole discretion. Before Purchaser returns a Product for non-warranty evaluation and repair, Purchaser must contact FLIR by visiting <http://www.flir.com> to request an evaluation and obtain an RMA. Purchaser is solely responsible for complying with all RMA instructions provided by FLIR including but not limited to adequately packaging the Product for shipment to FLIR and for all packaging and shipping costs. Upon receipt of an authorized non-warranty return, FLIR will evaluate the Product and contact Purchaser regarding the feasibility of and the costs and fees associated with Purchaser's request. Purchaser shall be responsible for the reasonable cost of FLIR's evaluation, for the cost of any repairs or services authorized by Purchaser, and for the cost of repackaging and returning the Product to Purchaser.

Any non-warranty repair of a Product is warranted for one hundred eighty days (180) days from the date of return shipment by FLIR to be free from defects in materials and workmanship only, subject to all of the limitations, exclusions and disclaimers in this document.

9.2 FLIR Test and Measurement Limited 2 Year Warranty

A qualifying FLIR Test and Measurement product (the "Product") purchased either directly from FLIR Commercial Systems Inc and affiliates (FLIR) or from an authorized FLIR distributor or reseller that Purchaser registers on-line with FLIR is eligible for coverage under FLIR's Limited Warranty, subject to the terms and conditions in this document. This warranty only applies to purchases of Qualifying Products (see below) purchased and manufactured after April 1, 2013.

PLEASE READ THIS DOCUMENT CAREFULLY; IT CONTAINS IMPORTANT INFORMATION ABOUT THE PRODUCTS THAT QUALIFY FOR COVERAGE UNDER THE LIMITED WARRANTY, PURCHASER'S OBLIGATIONS, HOW TO ACTIVATE THE WARRANTY, WARRANTY COVERAGE, AND OTHER IMPORTANT TERMS, CONDITIONS, EXCLUSIONS AND DISCLAIMERS.

1. PRODUCT REGISTRATION. To qualify for FLIR's Limited Warranty, Purchaser must fully register the Product directly with FLIR on-line at <http://www.flir.com> within Sixty (60) DAYS of the date the Product was purchased by the first retail customer (the "Purchase Date"). Qualifying PRODUCTS THAT ARE NOT REGISTERED ON-LINE WITHIN SIXTY (60) DAYS OF THE PURCHASE DATE WILL HAVE A LIMITED ONE YEAR WARRANTY FROM DATE OF PURCHASE.

2. QUALIFYING PRODUCTS. Upon registration, Test and Measurement products that qualify for coverage under FLIR's Limited Warranty are: VS70 Videoscope, VSAXx Articulation Camera, VSCxx Camera, VSSxx Probe Spool, VST handset, MR02 Pin Extension Probe, and TAxX not including accessories which may have their own warranty.

3. WARRANTY PERIODS. The applicable Limited Warranty Period measured from the Purchase data are:

| Products | Limited Warranty Period |
|--|-------------------------|
| VS70, VSAXx, VSCxx, VSSxx, VST, MR02, TAxX | TWO (2) Years |

Any Product that is repaired or replaced under warranty is covered under this Limited Warranty for one hundred eighty days (180) days from the date of return shipment by FLIR or for the remaining duration of the applicable Warranty Period, whichever is longer.

4. LIMITED WARRANTY. In accordance with the terms and conditions of this Limited Warranty, and except as excluded or disclaimed in this document, FLIR warrants, from the Purchase Date, that all fully registered Products will conform to FLIR's published product specifications and be free from defects in materials and workmanship during the applicable Warranty Period. PURCHASER'S SOLE AND EXCLUSIVE REMEDY UNDER THIS WARRANTY, AT FLIR'S SOLE DISCRETION, IS THE REPAIR OR REPLACEMENT OF DEFECTIVE PRODUCTS IN A MANNER, AND BY A SERVICE CENTER, AUTHORIZED BY FLIR. IF THIS REMEDY IS ADJUDICATED TO BE INSUFFICIENT, FLIR SHALL REFUND PURCHASER'S PAID PURCHASE PRICE AND HAVE NO OTHER OBLIGATION OR LIABILITY TO BUYER WHATSOEVER.

5. WARRANTY EXCLUSIONS AND DISCLAIMERS. FLIR MAKES NO OTHER WARRANTY OF ANY KIND WITH RESPECT TO THE PRODUCTS. ALL OTHER WARRANTIES, EXPRESS OR IMPLIED, INCLUDING BUT NOT LIMITED TO IMPLIED WARRANTIES OF MERCHANTABILITY, FITNESS FOR A PARTICULAR PURPOSE (EVEN IF PURCHASER HAS NOTIFIED FLIR OF ITS INTENDED USE FOR THE PRODUCTS), AND NON-INFRINGEMENT ARE EXPRESSLY EXCLUDED FROM THIS AGREEMENT.

THIS WARRANTY EXPRESSLY EXCLUDES ROUTINE PRODUCT MAINTENANCE, SOFTWARE UPDATES, AND REPLACEMENT OF FUSES, OR DISPOSABLE BATTERIES. FLIR FURTHER EXPRESSLY DISCLAIMS ANY WARRANTY COVERAGE WHERE THE ALLEGED NONCONFORMITY IS DUE TO NORMAL WEAR AND TEAR, OTHER ALTERATION, MODIFICATION, REPAIR, ATTEMPTED REPAIR, IMPROPER USE, IMPROPER MAINTENANCE, NEGLIGENCE, ABUSE, IMPROPER STORAGE, FAILURE TO FOLLOW ANY PRODUCT INSTRUCTIONS, DAMAGE (WHETHER CAUSED BY ACCIDENT OR OTHERWISE), OR ANY OTHER IMPROPER CARE OR HANDLING OF THE PRODUCTS CAUSED BY ANYONE OTHER THAN FLIR OR FLIR'S EXPRESSLY AUTHORIZED DESIGNEE.

THIS DOCUMENT CONTAINS THE ENTIRE WARRANTY AGREEMENT BETWEEN PURCHASER AND FLIR AND SUPERSEDES ALL PRIOR WARRANTY NEGOTIATIONS, AGREEMENTS, PROMISES AND UNDERSTANDINGS BETWEEN PURCHASER AND FLIR. THIS WARRANTY MAY NOT BE ALTERED WITHOUT THE EXPRESS WRITTEN CONSENT OF FLIR.

6. WARRANTY RETURN, REPAIR AND REPLACEMENT. To be eligible for warranty repair or replacement, Purchaser must notify FLIR within thirty (30) days of discovering of any apparent defect in materials or workmanship. Before Purchaser may return a Product for warranty service or repair, Purchaser must first obtain a returned material authorization (RMA) number from FLIR. To obtain the RMA number Owner must provide an original proof of purchase. For additional information, to notify FLIR of an apparent defect in materials or workmanship, or to request an RMA number, visit <http://www.flir.com>. Purchaser is solely responsible for complying with all RMA instructions provided by FLIR including but not limited to adequately packaging the Product for shipment to FLIR and for all packaging and shipping costs. FLIR will pay for returning to Purchaser any Product that FLIR repairs or replaces under warranty.

FLIR reserves the right to determine, in its sole discretion, whether a returned Product is covered under Warranty. If FLIR determines that any returned Product is not covered under Warranty or is otherwise excluded from Warranty coverage, FLIR may charge Purchaser a reasonable handling fee and return the Product to Purchaser, at Purchaser's expense, or offer Purchaser the option of handling the Product as a non-warranty return.

7. NON-WARRANTY RETURN. Purchaser may request that FLIR evaluate and service or repair a Product not covered under warranty, which FLIR may agree to do in its sole discretion. Before Purchaser returns a Product for non-warranty evaluation and repair, Purchaser must contact FLIR by visiting <http://www.flir.com> to request an evaluation and obtain an RMA. Purchaser is solely responsible for complying with all RMA instructions provided by FLIR including but not limited to adequately packaging the Product for shipment to FLIR and for all packaging and shipping costs. Upon receipt of an authorized non-warranty return, FLIR will evaluate the Product and contact Purchaser regarding the feasibility of and the costs and fees associated with Purchaser's request. Purchaser shall be responsible for the reasonable cost of FLIR's evaluation, for the cost of any repairs or services authorized by Purchaser, and for the cost of repackaging and returning the Product to Purchaser.

Any non-warranty repair of a Product is warranted for one hundred eighty days (180) days from the date of return shipment by FLIR to be free from defects in materials and workmanship only, subject to all of the limitations, exclusions and disclaimers in this document.



Corporate Headquarters

FLIR Systems, Inc.
2770 SW Parkway Avenue
Wilsonville, OR 97070
USA
Telephone: +1 503-498-3547

Customer Support

| | |
|----------------------------|--|
| Technical Support Website | http://support.flir.com |
| Technical Support Email | T&MSupport@flir.com |
| Service and Repair Email | Repair@flir.com |
| Customer Support Telephone | +1 855-499-3662 (toll free) |

Publication Identification No.: CM85-en-US
Release version: AA
Release Date: 2014 August
Language: en-US