



INSTRUCTION MANUAL

ENGLISH



TR-MARK III 250V

Turns Ratio Meter 3 Phase



Contents

1	Safety Precautions.....	4
2	Unpacking.....	6
3	Introduction.....	7
3.1	History.....	7
3.2	General.....	7
3.3	Advantages & Features.....	8
3.4	System Details.....	9
3.4.1	System Check.....	9
3.4.2	Transformer Turns Ratio Testing.....	9
3.4.3	Transformer Turns Ratio Meter uses.....	10
3.4.4	Limitations of Turns Ratio Testing.....	11
4	Quick Start Guide.....	12
4.1	Instrument operation.....	12
4.2	Connection to Test Object.....	13
4.2.1	Hooking up a transformer.....	13
4.2.2	Comparison of International Standards.....	14
5	Operation Elements Field Case.....	15
5.1	Front Panel Overview.....	15
5.2	Control Elements and Plugs.....	15
5.2.1	Fuse, Mains Input and Mains Switch.....	15
5.2.2	Ground Terminal.....	15
5.2.3	Emergency Stop.....	16
5.2.4	High Voltage Side Connector.....	16
5.2.5	Low Voltage Side Connector.....	16
5.2.6	3 Phase Extension (T-REX).....	16
5.2.7	External.....	16
5.2.8	Interface.....	16
5.2.9	Safety Indicator.....	16
5.2.10	Display and Touch Panel.....	16
5.2.11	Thermal Printer.....	16
6	Operation Elements Rack.....	17
6.1	Rack: Front Panel Overview.....	17
6.2	Rack: Rear Panel Overview.....	17
7	Transformer, Measurement and Data Structure.....	18
7.1	Introduction.....	18
7.2	How it works.....	18
8	Operating Menu.....	20
8.1	Main Screen.....	21
8.1.1	Operating on a simple screen, no Transformer Data entered.....	21
8.1.2	Further Options of Main screen.....	23
8.1.2.1	Change Test Voltage.....	23
8.1.2.2	Continuous Measurement and Stop Measurement.....	23
8.1.2.3	Print and Save, Turns Ratio or Voltage Ratio.....	24
8.1.3	Operating on an advanced Screen, Transformer Data entered.....	25
8.1.3.1	Pass, Fail and Transformer Name.....	25
8.1.3.2	Turn Ratio and Voltage Ratio.....	26
8.1.4	Taps.....	27
8.1.5	More Taps.....	29
8.1.6	Tertiary Winding System.....	30
8.2	New.....	32
8.2.1	New Transformer.....	33
8.2.1.1	Simple Transformer, no taps.....	33
8.2.1.2	Taps.....	34
8.2.1.3	Tertiary Winding System.....	35
8.2.2	Load from Archive.....	36
8.2.3	Copy Actual Transformer.....	37
8.2.4	New Measurement.....	38
8.2.5	Working with Templates.....	38
8.3	Info.....	39
8.3.1	Enter Tap Changer Data by Wizard.....	41
8.3.2	Enter Tap Changer Data manually.....	41
8.4	Archive.....	42



8.5	Setup.....	43
8.5.1	General.....	44
8.5.1.1	License.....	44
8.5.1.2	About.....	44
8.5.1.3	Clock.....	44
8.5.1.4	Cursor.....	44
8.5.1.5	Update.....	44
8.5.1.6	Language.....	44
8.5.1.7	Service.....	44
8.5.2	Operators.....	45
8.5.3	Standards.....	45
8.5.4	Printer.....	45
8.5.5	Color.....	45
9	Technical Specification.....	46
10	Interfaces.....	49
10.1	Hardware.....	49
10.2	T-Base (Software).....	50
10.3	TR-MARK III USB Device Interface.....	51
10.3.1	Hardware Protocol.....	51
10.3.2	Raytech Native USB Driver.....	51
10.3.3	Software Protocol.....	52
10.3.3.1	When using Raytech Toolbox.....	52
10.3.3.2	When using SDK (Software Development Kit).....	52
10.4	TR-MARK III Serial Communication Interface.....	53
10.4.1	Hardware Protocol.....	53
10.4.2	Software Protocol.....	53
10.4.2.1	Switch to Remote.....	53
10.4.2.2	Switch to Local.....	53
10.4.2.3	Syntax of Commands.....	54
10.5	TR-MARK III Remote Commands.....	54
A.	Application Notes.....	57
A.A	Real Three Phase Voltage Option T-Rex.....	57
A.B	Current Transformer Testing.....	58
A.B.A	Introduction.....	58
A.B.B	Usual Measurement.....	58
A.B.C	Low Impedance.....	59
A.B.D	Info.....	59
A.B.E	CTs with Taps (Tapped Secondary).....	59
B.	Test Reports.....	60
B.A	Internal Printer.....	60
B.B	External Printer.....	61
C.	Extended Safety Interlock Option (70049-A).....	62
C.A	A Look under the Hood.....	63
C.B	Dummy Plug – Use without external Interlock.....	63
D.	Firmware Update.....	64
E.	Error Messages.....	65
F.	Warranty Conditions.....	66
G.	Trouble Shooting.....	67
H.	Contacts.....	67



1 Safety Precautions

The following safety precautions must be observed during all phases of operation, service and repair of this instrument. By purchasing this equipment the purchaser assumes all liability for the operation and use of this equipment. The intended use of the instrument, its design and manufacture, is to be conducted within the precautions or other specific warnings located within this manual. Failure to comply with these precautions and other specific warnings violates safety standards of design, manufacture, and intended use. Raytech GmbH assumes no liability for the operation and use of this equipment.

SAFE OPERATION:

Only qualified knowledgeable persons should be permitted or attempt to operate this test equipment. All test personnel should fully familiarize themselves with the correct application and operation of this and all test equipment prior to operation. Persons directly and indirectly engaged in the operation of this test equipment should keep clear of all high voltage apparatus while conducting tests and measurements.

BEFORE APPLYING POWER:

Do not vary the input power source voltage level (IE...Connected to a variable AC power source).

The TR-MARK III auto-senses the input power from the mains plus from 100 to 240 VAC 50/60Hz. Varying the input voltage will cause the test voltage to vary and result in a higher or lower test voltage than indicated. Heavy changes may even damage the device.

GROUND THE INSTRUMENT:

To minimize shock hazard, the instruments Ground Terminal must be connected to a properly grounded receptacle. In many cases, the quality of the safety ground provided by the power cord does not fulfill safety needs. Also the power cord supplied with the equipment must be connected an electrical receptacle with an electrical ground (safety earth ground). Non grounded instruments are dangerous and may cause instrument damage.

KEEP AWAY FROM LIVE CIRCUITS:

Operating personnel must not remove instrument covers. Component replacement and internal adjustments must be made by qualified service personnel. Do not replace components with power cable connected. To avoid injuries, always disconnect power, discharge circuits, and remove external voltage sources before touching components.



WARNING!

⇒ Never connect TR-MARK III to a transformer, which is energized or connected to power lines.



DO NOT OPERATE IN AN EXPLOSIVE ATMOSPHERE:

Do not operate the instrument in the presence of flammable gases or fumes.

DO NOT SUBSTITUTE PARTS OR MODIFY INSTRUMENT:

Because of the danger of introducing additional hazards, do not install substitute parts or perform any unauthorized modification to the instrument. Return the instrument to a Raytech service department for service to ensure proper operation and that safety features are maintained.

Instruments, which appear damaged or defective, should be made inoperative and secured against unintended operation until they can be repaired by qualified service personnel.

DO NOT TOUCH TEST LEADS WHILE TEST VOLTAGE IS ON

Your TR-MARK III is equipped with 100V and 250V test voltage. These voltages can be dangerous to humans, animals and equipment.



WARNING!

⇒ Never touch test Leads of TR-MARK III while test voltage is on
Check safety indicator on front panel.



2 Unpacking

A complete shipment consists of the following items:



Instrument



Cable bag



H and X lead cable



2 Extension cables



Power cord (depending
on country of distribution)



USB memory stick



Accessories:
2 paper rolls and
and 2 fuses

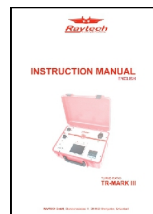

Instruction:
This manual

If any of the above items are missing or damaged contact your local representative or Raytech GmbH immediately.



NOTE

⇒ The TR-MARK III field case is a waterproof design. When the case is unlocked, a small hole automatically opens, to compensate atmospheric pressure changes.



3 Introduction

3.1 History

Raytech first developed the Transformer Turns Ratio **Spy (TR-Spy)** for high degree of accuracy for the research and development of transformers. This technology was then packaged into a portable test system for use by transformer manufacturers, rebuild shops, and electrical maintenance crews. This first system had become the most widely respected precision instrument for the ease of use, design, and operation. It was developed with the assistance of transformer manufacturer's and utility test crews.

The **TR-Spy MARK II** took this initial development and added many new features to the system including a large memory base, external control for tap changer testing, and automatic voltage level detection test. The TR-Spy MARK II was a completely new approach in technology and has become the standard for ratio testing.

Now **the TR-MARK III** offers new features and increased accuracy to make it a perfect system. A color LCD with back lighting and touch screen increases handling and user comfort. Two USB interfaces make it easy to store measurements on external storage devices and transfer easily to a personal computer. Test Reports; just print them on the internal printer or from your computer.

3.2 General

Ease of use: This system is designed to be easily used and understood. Once the buttons and few menus are learned the system is very simple to understand and operate. This intelligent system analyzes the configuration of a transformer and performs all required measurements automatically for Voltage Ratio, Turns Ratio, Current, and Phase Displacement. The system can operate a full 3 phase testing sequence with a single push button operation. Connect the leads, Select the transformer configuration then press GO to test.

Impressive Accuracy: The TR-MARK III is a high precision, fully automatic, microprocessor based, Single and Three Phase Transformer Turns Ratio Test system. This system is designed for highly accurate readings on-site with laboratory precision. It is the most accurate system available.

Unique Measuring Technique: This newly designed technique of measurement incorporates a high precision dual-vector voltage meter for ratio readings and a rectification resolution circuit for phase displacement (vector group). The phase displacement (vector group) can be automatically detected and displayed without operator intervention.

Operation: The TR-MARK III first applies a small voltage on the HIGH winding side of the transformer and measures back through the LOW side of the transformer. Analysis is made and the system determines whether a test can be conducted. Then the system applies the test voltage on the HIGH winding side of the transformer and measures the voltage back through the LOW side of the transformer. This technique has been determined to be the safest possible method of ratio testing. The results are reported on the easy to read touch screen display.

Compact Design: The TR-MARK III is a lightweight system designed with its own rugged waterproof field case.



Simple Maintenance: There is no maintenance required. There is no calibration procedure (no potentiometers to turn). This is due to the utilization of high precision components in the design.

Advanced Protection: Upon powering on the system initializes itself with a self-calibrating, circuit checking sequence. If any problems are detected during this initialization period, or during operation, the operator is immediately notified. The system constantly monitors the condition of the transformer under test. The TR-MARK III can even recognize shorted leads and will terminate the test without any damage to the test equipment. This works especially well when test leads accidentally fall free from the transformer while under full voltage measurement. Accidental interchanging of the test leads on the High and Low voltage side are also detected and the measurement is safely halted

3.3 Advantages & Features

- Color LCD with backlighting and touch screen
- Automatic measurements of Voltage, Turns Ratio, Current, and Phase displacement
- Easy one time hook up to the transformer
- Automatic test voltage range
- Displays deviation from a nominal ratio
- Graphical tap changer display
- Tap changer interface (In- and Output)
- Load on test object <0.05 VA
- Measures Power transformers, PT's and CT's
- Displays % error vs. name plate value
- Automatic phase vector detection
- Enhanced heavy-duty protection circuitry
- Extremely rugged (can withstand a drop test of 1 meter)
- Data exchange via USB-Key
- Internal Printer
- 2 Years standard warranty



3.4 System Details

3.4.1 System Check:

The instrument is Line operated. It is designed to be used with voltage power sources (mains power) between 100-240 VAC 50/60Hz. The system performs a self-check each time that it is powered on. The User should always visually inspect all connectors, cables and devices to be measured to avoid any safety issues.

3.4.2 Transformer Turns Ratio Testing:

A Transformer Turns Ratio Meter does exactly as its name implies; it is used primarily for checking the ratio of Turns of wires of the primary side and the secondary side of a transformer. The Turns Ratio test set does not tell exactly how many turns of wire are in the primary and secondary coils. But rather, it measures and displays the **Ratio** of (or comparison of) the number turns in the primary coil to the number of turns in the secondary coil.

This is an extremely useful device to check for shorted turns and incorrect settings of tap changers. The TR-MARK III has an additional feature of allowing the operator to measure the actual phase angle and vector relationship of the windings.

It is important to understand that the Nameplate Ratio on most transformers is the Voltage ratio (Voltage in: Voltage out) and this Ratio is determined, basically, by the number of turns of wire on the Primary (High side), the number of turns of wire on the Secondary (Low Side).

On a single phase Transformer the Turns Ratio is the same as the Voltage Ratio.

A Single Phase transformer:

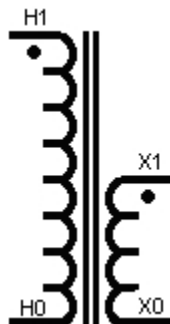

For example: The High Side Winding may contain 940 Turns: Low Side Winding 440 Turns.

Therefore:

$$\text{TurnsRatio} = \frac{\text{PrimaryTurns}}{\text{SecondaryTurns}} = \frac{940}{440} = 2.136$$

With three (3) Phase Transformers of different configurations, Turns Ratio and Voltage Ratio can be, and usually are different.



NOTE

- ⇒ The TR-MARK III makes all the calculations and interconnections required, when the correct configurations of single (1) phase and three (3) phase transformers are selected. In most cases, no other external connections, other than the test leads provided, are required. But please check chapter '1 Safety Precautions' for safety grounding.
- ⇒ Hooking up to a transformer:
The TR-MARK III protects against a wrong hook-up to a transformer or testing a severely defective transformer. Every effort has been made to alert the operator when something is wrong.
- ⇒ Negative (reverse polarity) hook up is also automatically detected.

3.4.3 Transformer Turns Ratio Meter uses:

A Transformer Turns Ratio Meter is very useful as a tool for investigating problems associated with the core, the windings, and the tap changer of transformers and should be used for:

1. Identify shorted turns and finding turn errors
2. Defective and incorrect tap settings
3. Finding mislabeled terminals and mislabeled nameplates

Turns Ratio testing is a required test during the manufacture of transformers. It is too a part of a good routine preventative maintenance program as well as for Acceptance testing.



3.4.4 Limitations of Turns Ratio Testing:

In general, there are few limitations on ratio testing of Transformers. However, there are limitations to be aware of when attempting to test the following transformer:

- Phase relationships other than 30°.
- Non symmetrical Zig Zag windings
- Uncentered neutral points.
- Suspected broken, damaged, or missing core laminations.

In the cases listed above, Raytech recommends the use of the optional unit, model T-Rex, in conjunction with the TR-MARK III. To get further Information on the T-Rex please check chapter 'A.A, T-Rex', or contact Raytech to get additional details and information.

Also **current transformers** are in effect nothing else than opposite wound voltage transformers. Most current transformers can be tested by TR-MARK III. Please see chapter 'A.B Current Transformer Testing' for details about CT testing.

You may find some small low power current transformer difficult to test by TR-MARK III. In this case, please contact Raytech for information about TR-1.



4 Quick Start Guide

4.1 Instrument operation



- ⇒ Wait until the green light shows “Save” before handling the cables
- ⇒ If you are new to transformer turns ratio testing, please read the entire manual carefully before operating this equipment.
- ⇒ All operation can be done by the integrated touch panel.
- ⇒ “Overcurrent” error will be displayed with some configurations.
- ⇒ It is OK to run through all the transformer selections with the leads tied together.

1. Switch on the instrument.
To repeat last Measurement, tap 'GO ABC'. Tap 'New' for a new Transformer.

P	V Ratio	Dev [%]	I [mA]	P [°]	Pass
A	0.8660		0.0	+0.01	
B	0.8660		0.0	+0.00	
C	0.8660		0.0	+0.01	

2. In case of 'New Transformer':
Select Transformer Type and Test Voltage, then touch 'Go'

Transformer Setup

Yn : Δ 1

Utest: 40V

No Tap No Taps

Tertiary

Buttons: 10V, 40V, 100V, Auto

3. Press 'Go ABC' or 'Go...' to start a measurement.

P	V Ratio	Dev [%]	I [mA]	P [°]	Pass
A					
B					
C					

4. Get the results

P	V Ratio	Dev [%]	I [mA]	P [°]	Pass
A	1.7320		0.0	+0.01	
B					
C					



WARNING!

- ⇒ Do not touch the test clips if the safety indication is red.
Test voltage will be present.



4.2 Connection to Test Object

4.2.1 Hooking up a transformer

This section describes a typical, step by step, operation of the TR-MARK III.

Plug the TR-MARK III into an available grounded outlet with 110/240 VAC 60/50 Hz power source.

Connect the TR-MARK III to the transformer under test with the colored test leads and if required use the 10 meter red measuring cable extensions. The extensions will connect to the multicolor leads and the connectors on the front panel. Check the nameplate information of the transformer. If the nameplate is missing it is still possible to test the transformer by a trial and error method. The TR-MARK III test set is designed to detect errors in transformer hook ups. Contact Raytech Service & Support department if you need assistance.



NOTE

⇒ No extra external leads or jumpers are required when using the TR-MARK III . All interconnections are made internally.

Single Phase Transformer

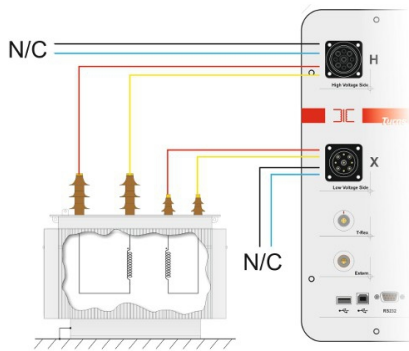

Three Phase Transformer

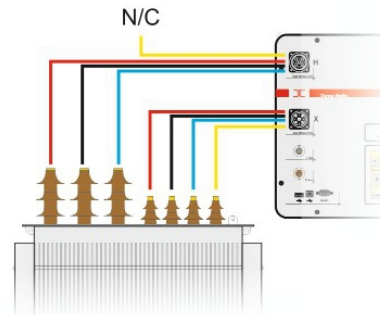

The colored leads are marked to indicate to which transformer terminal they must be connected for correct operation.

For a Single (1) phase transformer or Auto-transformer use leads:

WIRE COLOR	Primary ANSI IEC	Secondary ANSI IEC
- RED indicates	H1 U phase (Red clip) or	X1 u phase (Black clip)
- YELLOW indicates	H0 N neutral (Red clip) or	X0 n neutral (Black clip)

For a Three (3) phase transformer use leads:

WIRE COLOR	Primary ANSI IEC	Secondary ANSI IEC
- RED indicates	H1 U phase (Red clip) or	X1 u phase (Black clip)
- BLACK indicates	H2 V phase (Red clip) or	X2 v phase (Black clip)
- BLUE indicates	H3 W phase (Red clip) or	X3 w phase (Black clip)
- YELLOW indicates	H0 N neutral (Red clip) or	X0 n neutral (Black clip)



4.2.2 Comparison of International Standards

High Winding Side:

Wire Color	ANSI	Wire Color	IEC	Wire Color	Australian
RED	H1	RED	U	RED	A
BLACK	H2	BLACK	V	YELLOW	B
BLUE	H3	BLUE	W	BLUE	C
YELLOW	H0	YELLOW	N	BLACK	N

Low Winding Side:

Wire Color	ANSI	Wire Color	IEC	Wire Color	Australian
RED	X1	RED	u	RED	a
BLACK	X2	BLACK	v	YELLOW	b
BLUE	X3	BLUE	w	BLUE	c
YELLOW	X0	YELLOW	n	BLACK	n



NOTE

⇒ This manual refers to the ANSI standards for all examples. To change the standard in the test instrument please refer to chapter '8.5.3 Standards'.



WARNING!

- ⇒ BEFORE OPERATING THIS OR ANY OTHER TEST EQUIPMENT READ ALL SAFETY WARNINGS AND UNDERSTAND THEM FULLY.
- ⇒ DO NOT VARY INPUT VOLTAGE (MAINS) AFTER POWERING ON TEST SET.
- ⇒ The TR-MARK III auto-senses the input (mains) voltage from 100 TO 240 VAC 50 / 60 Hz.
- ⇒ The TR-MARK III then "locks-in" the test voltage range. If the input voltage (mains) is varied after the TR-MARK III was powered on the actual test voltage may be higher or lower than indicated and system may get damaged



5 Operation Elements Field Case

5.1 Front Panel Overview

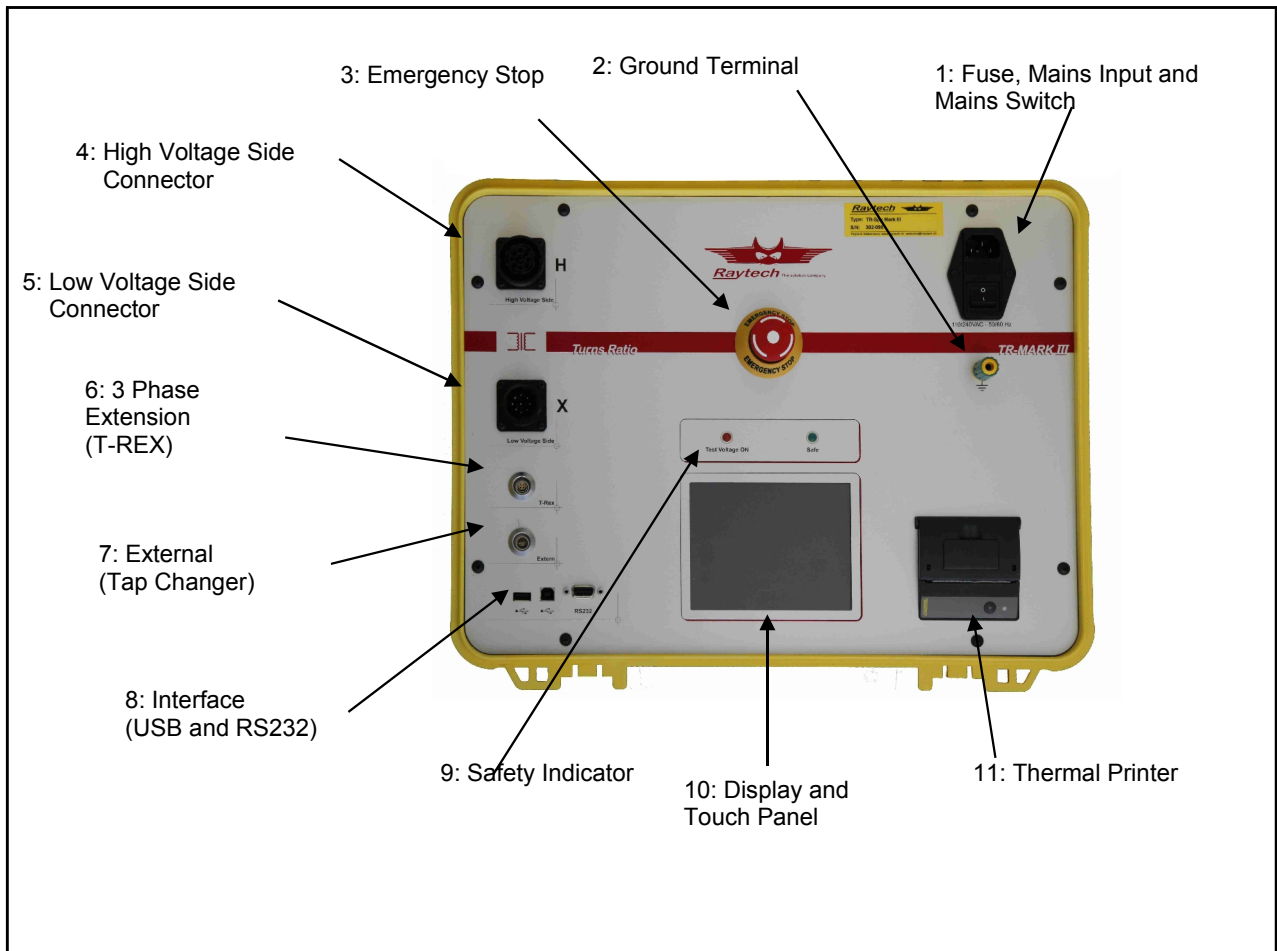

5.2 Control Elements and Plugs

5.2.1 Fuse, Mains Input and Mains Switch

A 2A fuse (slow blow) protects the device. Use only the correct fuse type to replace it.

5.2.2 Ground Terminal

Use this terminal to connect an additional ground line, if your mains cable does not provide a ground line. Use it also if you are not sure, that the local installation provides a low resistive ground.



5.2.3 Emergency Stop

Press to Stop. The measurement will cease and halt Voltage to the test leads immediately. Turn clockwise to release. The device will remain in a safe state.

5.2.4 High Voltage Side Connector

The connection for the High side lead (H) to the test object.

5.2.5 Low Voltage Side Connector

The connection for the Low side lead (x) to the test object.

5.2.6 3 Phase Extension (T-REX)

The TR-MARK III provides this separate plug to connect and control the 3 Phase Voltage Extension T-REX.

5.2.7 External

This port is used for an external connection to a tap changer dry contact. This port can also be connected to the optional external control switch TRO-203 (Part No. 30047) for a remote start of the test sequence. Please see chapter '10.1 Hardware' for details.

Note: If the device is supplied with the option "extended safety circuit", for instance an external safety interlock can be connected here. If not, a dummy plug as a jumper is needed. For details please see chapter 'C Extended Safety Interlock Option (70049-A)'.

5.2.8 Interface

RS232 and USB 2.0. Please see chapter '10.1 Hardware' for Details.

5.2.9 Safety Indicator

Green Light on: No voltage applied to test leads. System in safe standby mode.
Red Light on: Indicates there is test voltage on test leads. System is testing.

5.2.10 Display and Touch Panel

The TR-MARK III can be easily manipulated and fully controlled by the touch screen panel. If preferred, an external mouse can be connected to the USB Port to control the system.

5.2.11 Thermal Printer

Allows you to quickly get your results on paper by using the built-in thermal printer.



6 Operation Elements Rack

Please find legend of elements on previous page.

6.1 Rack: Front Panel Overview

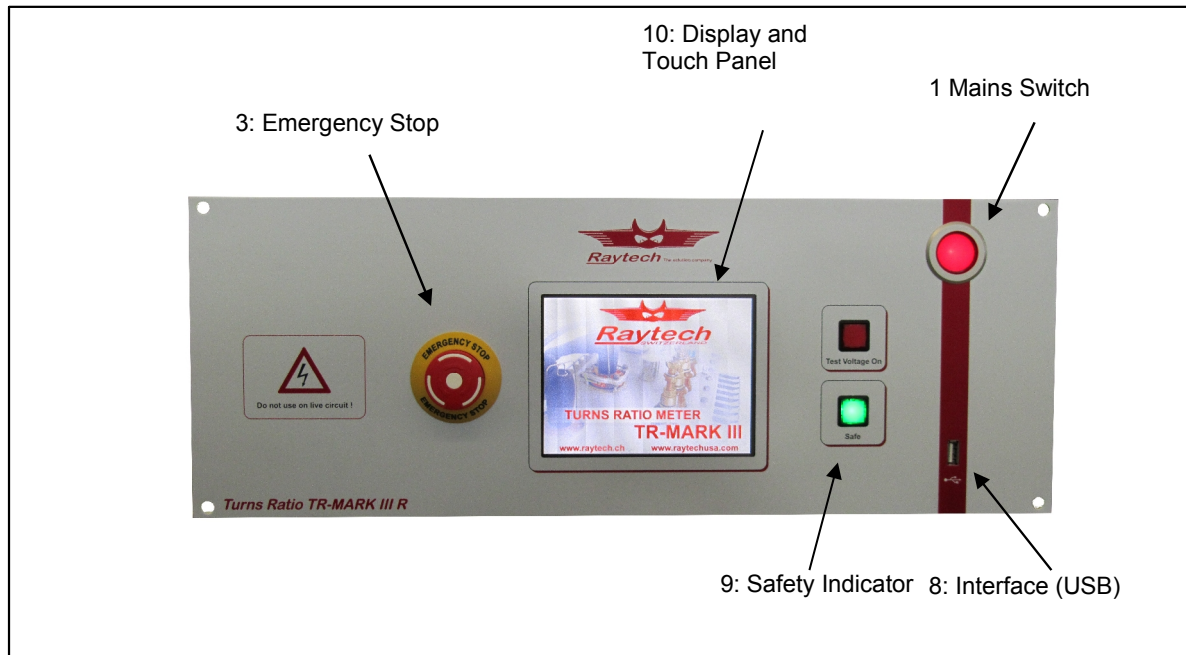

6.2 Rack: Rear Panel Overview

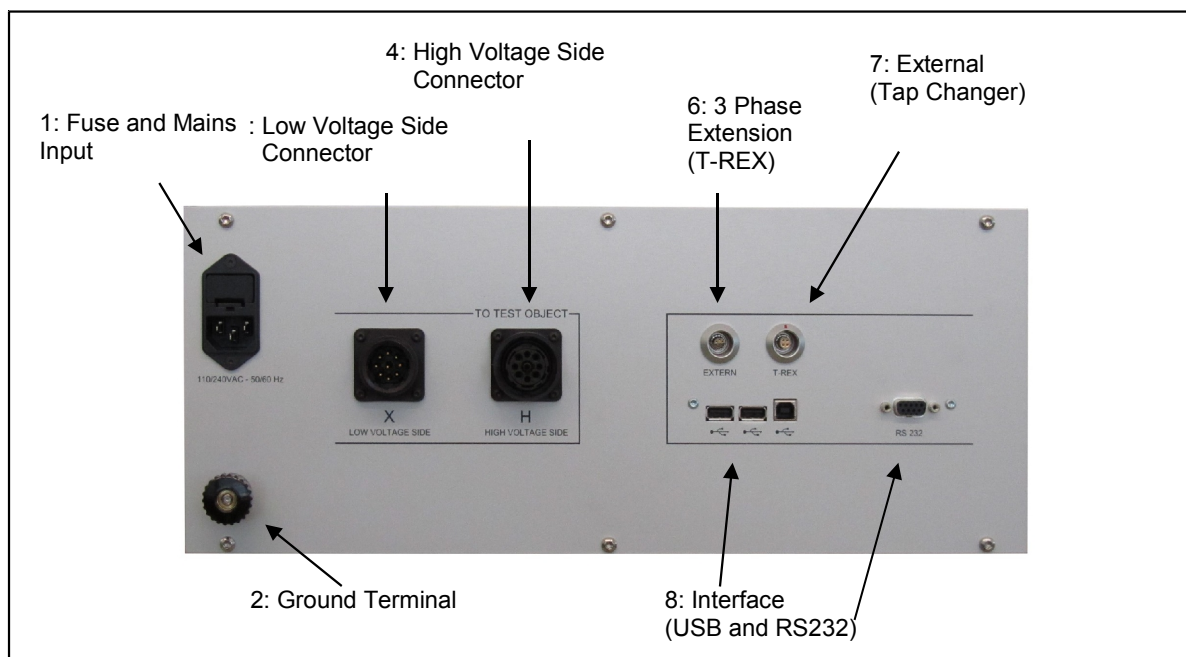



7 Transformer, Measurement and Data Structure

7.1 Introduction

There are many other instruments, that do a measurement and offer the possibility to store a measured value. This is a very useful feature that saves a lot of time and eliminates errors of writing down values by the operator. But still you have to do the handling and organization of the measured data on your own. This may introduce one day mistakes into your data set, especially when several measurements will be taken at once and sorted after words, or if several operators use the same storage device.

7.2 How it works

With TR-MARK III we offer another powerful tool, that increases comfort in handling many transformers which are tested time after time. You do not have to sort a stored measurement anywhere. Once a transformer, or let's say a transformer profile, is created, several measurements directly can be attached to it.

The profile or transformer contains the general (header) data. An attached result contains the measurement of all transformer phases. Or to define it more exactly:

A transformer / profile contains:

- Number of winding systems
- Type of winding systems
- Test voltage
- Rated voltages (primary, secondary, tertiary)
- Name plate info (name, serial number, location, manufacturer, type and remarks)
- Max. ratio deviation and standard (ANSI, IEC, Australian,...)

A measurement contains

- Measured results of all phases (ratio, deviation, current, phase angle)
- Date and time
- Operator name

What you usually will do is creating a new transformer (profile), do a measurement and store it. In this case the profile and the actual measurement will be stored.

Or you load an existing transformer, do a measurement and store it. In this case, the new measurement will be attached or let's say stored with the loaded transformer.

Please find this illustrated on the following page.



NOTE

⇒ There is no difference for you between saving a transformer or attach the actual measurement. Both is done with the button 'save' in Main screen. See chapter '8.1.2.3 Print and Save, Turns Ratio or Voltage Ratio'

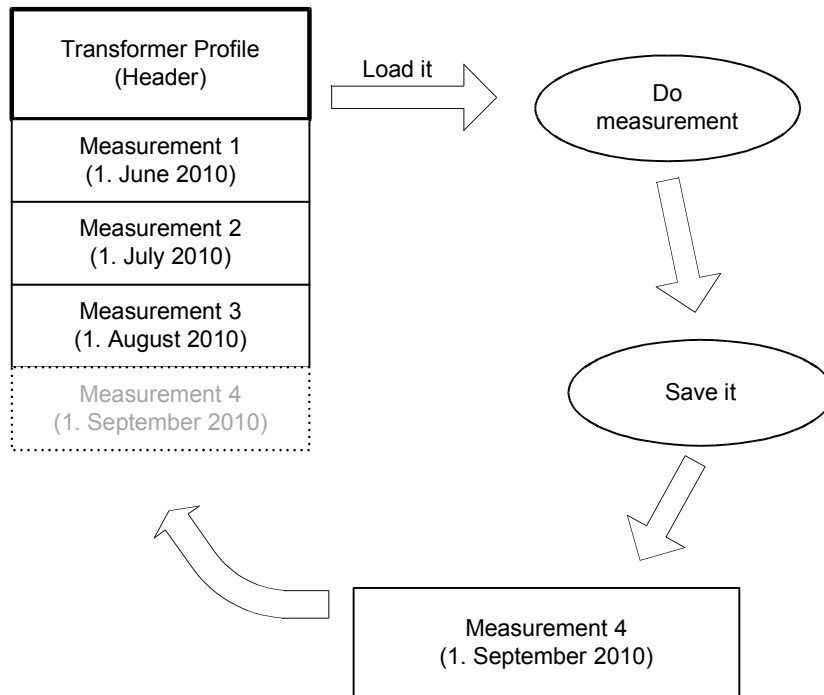

This shows a Transformer, that has been created and measured for the first time on June 1th 2010. Profile and Measurement was saved by touching the 'save' button in Main Screen. ¹

Then, this transformer was measured again, every 1st of a month. This means, that the transformer was loaded from archive again², measurement was done and the measurement was attached by touching the 'save' button in main screen.

In our example, now it is the 1st of September. And again, the transformer is loaded and measurement is done. This means, that a new measurement data block is created. And it is saved and attached by touching 'save'.

1

¹ Please see chapter '8.1.2.3 Print and Save, Turns Ratio or Voltage Ratio' for details

² Please see chapter '8.2.2 Load from Archive' or '8.4 Archive' for details



8 Operating Menu

TR-MARK III Menu structured as shown in the figure below. Pressing a Cancel button, will bring you one layer towards Main Screen.

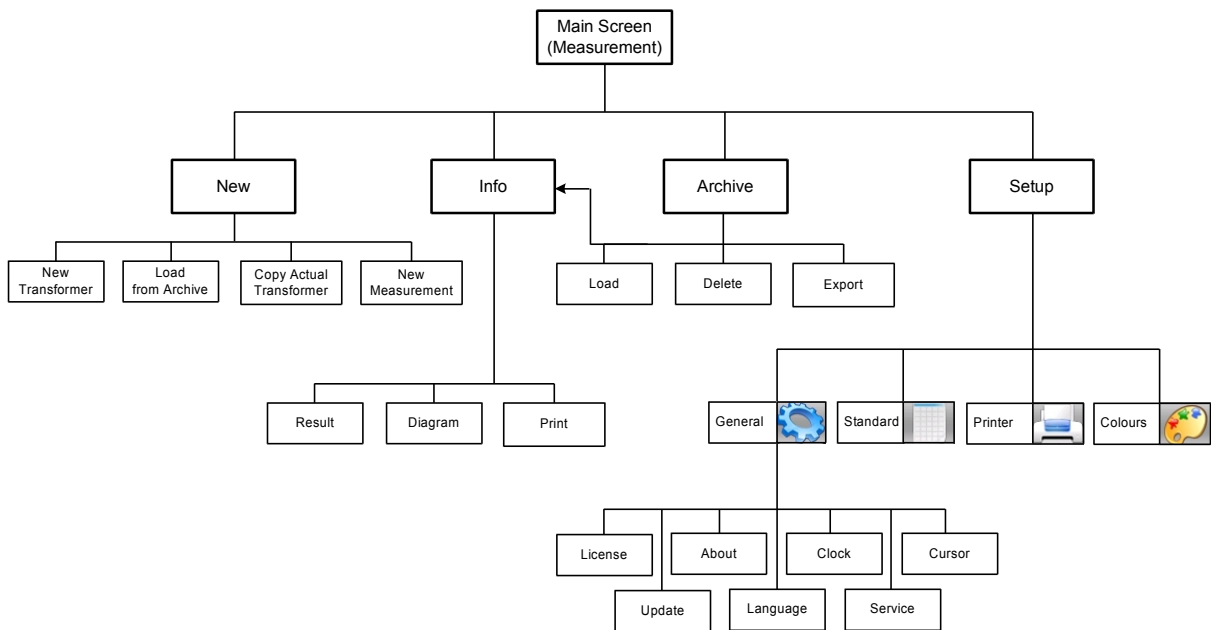



8.1 Main Screen

8.1.1 Operating on a simple screen, no Transformer Data entered

If a new Transformer is entered to TR-MARK III, the main screen appears as followed:

14 49					
Y:y-0			Ut=100V		
1U-1W:2U-2W2N			VR = - kV : - kV		
P	V Ratio	Dev [%]	I [mA]	P [°]	Pass
A					
B					
C					
Go ABC		Go...		Save	
New	Info	Archive	Setup		

Main Screen is the basic platform of TR-MARK III operation. On this screen, you will find buttons, indications and results.

Now lets start with the 'Go' buttons. Press '**Go ABC**' to measure all three phases A, B and C in one cycle. TR-MARK III will display automatically any complete result. Finally main screen will appear as followed:

14 50					
Y:y-0			Ut=100V		
1W-1V:2W-2V2N			VR = - kV : - kV		
P	V Ratio	Dev [%]	I [mA]	P [°]	Pass
A	1.0000		0.1	+0.00	
B	1.0001		0.1	+0.01	
C	1.0001		0.1	+0.00	
Go ABC		Go...		Print	Save
New	Info	Archive	Setup		

This is also the display you will find after switching on the instrument, if a measurement was finished before it was switched off.



If you are not up measure all three phases at once, you can also touch 'Go...' to choose a phase to be measured. In the appearing window every Phase A, B and C has its own button. Touch one of those buttons to start a single phase measurement. In this case no other phase than the chosen one will be tested.

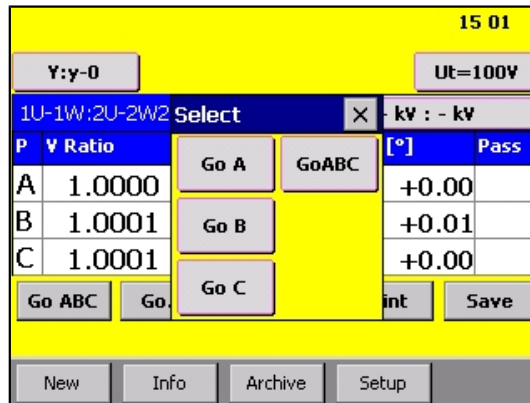

This Option is also used to do a 'GO Tap' if you have tabs. Please see chapter '8.1.4 Taps' about how to define a transformer with taps.



8.1.2 Further Options of Main screen

8.1.2.1 Change Test Voltage

Let's have a look to further measurement settings provided by main screen.

TR-MARK III offers three Test Voltage settings for common transformers. To change Test Voltage, just touch the button with the 'Ut=...' on the upper right. A selection window appears.

Then select new Test Voltage by touching the button with the Test Voltage of your choice written on it.

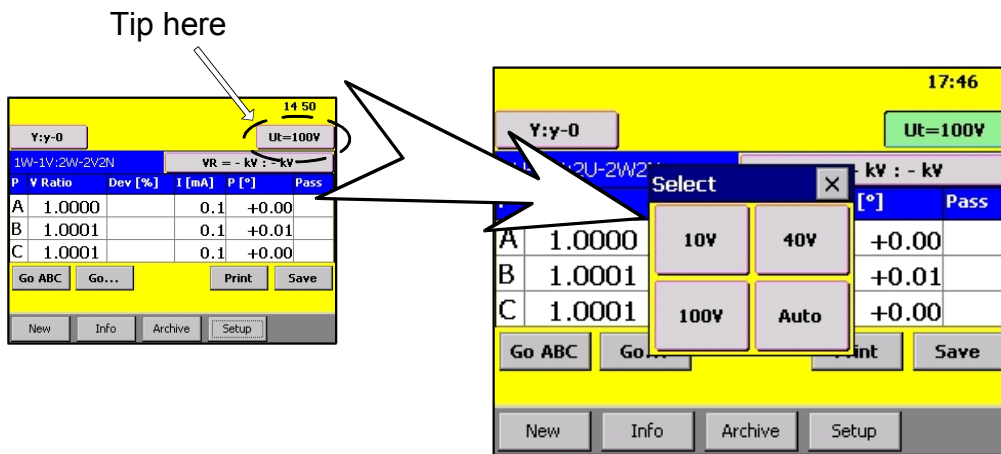

8.1.2.2 Continuous Measurement and Stop Measurement

On TR-MARK III a running measurement is indicated by a progress bar. In this stage the buttons in the lower part of the display disappear, and the two buttons **Cont** and **Stop** appear. Touching Cont (continuous) will lead to permanent measurement of the marked phase.

In continuous mode, the 'cont' button will convert to a 'Next'. Use this button to switch to the next phase and stay in continuous mode.

Stop will immediately stop measurement in common and continuous mode.

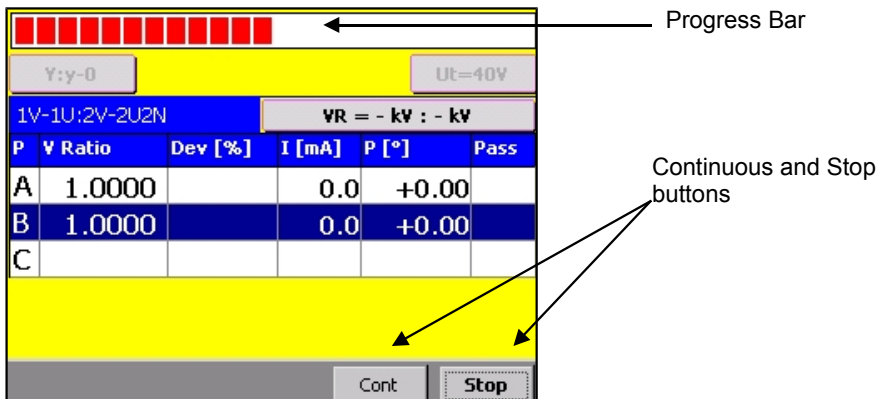



8.1.2.3 Print and Save, Turns Ratio or Voltage Ratio

After every measurement the results can be printed or stored. Use 'Print' and 'Save' to do so.



NOTE

⇒ 'Save' has only once an effect. To save several measurements, see chapter '8.2.4 New Measurement'.

Of course TR-MARK III provides conversion of voltage ratio in to turn ratio. You can easily switch between these two options

Turns Ratio and Voltage Ratio:

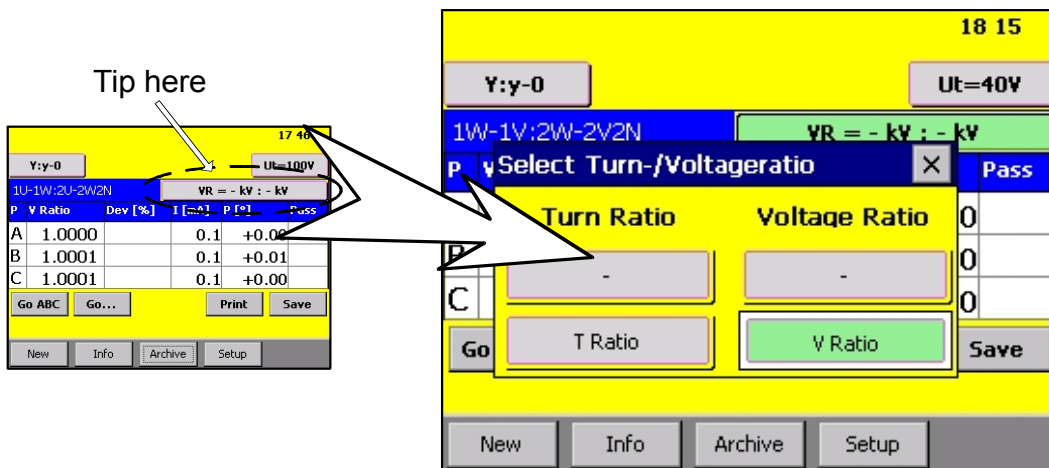

NOTE

⇒ Never mind about the unfilled buttons. We will talk on it later in 8.1.3.2 Turn Ratio and Voltage Ratio



8.1.3 Operating on an advanced Screen, Transformer Data entered



NOTE

⇒ Please check chapter '8.3 Info' if you are not familiar with entering and editing Transformer Data. Using Transformer Data may offer several benefits to you.

8.1.3.1 Pass, Fail and Transformer Name

When in 'Info' Rated Voltage Data are entered, Results are automatically checked. An indication for pass or fail is displayed for each phase. To provide more details, deviation appears in column *Dev*. In chapter '8.3 Info', read about section 'General' for details about pass/fail criteria.

Pass:

18:36						
Y:y-0		Ut=40V				
1U-1W:2U-2W2N			VR = 1 kV : 1 kV			
P	V Ratio	Dev [%]	I [mA]	P [°]	Pass	
A	1.0000	0.00	0.0	+0.00	✓	
B	1.0000	0.00	0.0	+0.00	✓	
C	1.0000	0.00	0.0	+0.00	✓	
Go ABC		Go...		Print		Save
New	Info	Archive	Setup			

Fail:

18:36						
Y:y-0		Ut=40V				
1U-1W:2U-2W2N			VR = 1 kV : 0.5 kV			
P	V Ratio	Dev [%]	I [mA]	P [°]	Pass	
A	1.0000	-50.0	0.0	+0.00	✗	
B	1.0000	-50.0	0.0	+0.00	✗	
C	1.0000	-50.0	0.0	+0.00	✗	
Go ABC		Go...		Print		Save
New	Info	Archive	Setup			

When a Transformer Name is entered, it is displayed here



18:41						
Y:y-0		Ut=40V				
1U-1W:2U-2W2N			VR = 1 kV : 1 kV			
P	V Ratio	Dev [%]	I [mA]	P [°]	Pass	
Transformer: 'Raytech Manual'						
A	1.0000	0.00	0.0	+0.00	✓	
B	1.0000	0.00	0.0	+0.00	✓	
C	1.0000	0.00	0.0	+0.00	✓	
Go ABC		Go...		Print		Save
New	Info	Archive	Setup			



8.1.3.2 Turn Ratio and Voltage Ratio

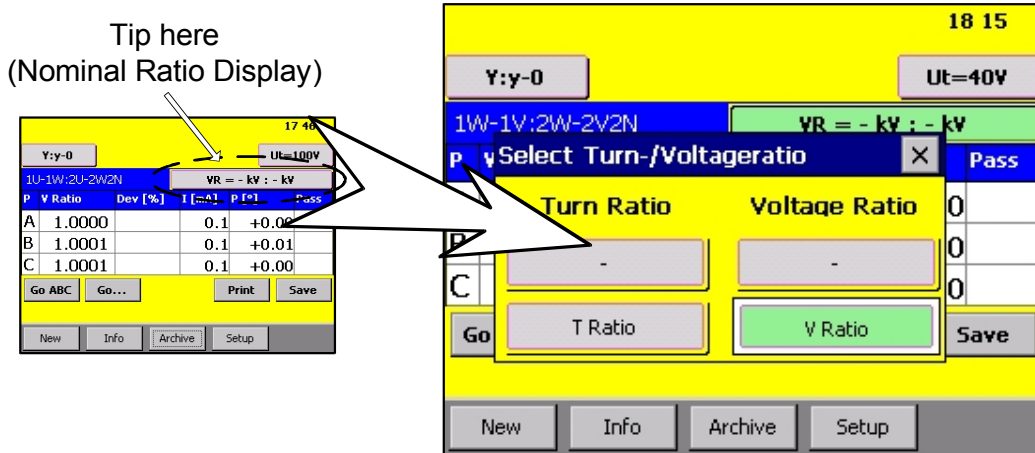

To simplify your work, we provide up to four display options for the entered transformer data.

There are two criteria important for your display. Do you need a Voltage or a Turns Ratio? And do you prefer a calculated nominal ratio, based on the voltages in the info filed, or do you prefer to see the nominal ratio as “primary voltage : secondary voltage”?

If you change between Turn and Voltage Ratio, nominal and measured Ratio will be displayed in the format of your choice. Calculated or not calculated value affects only nominal ratio display.

The following example shows a D:y Transformer and what display options TR-Mark III provides:

3464 : 1000 turns
10kV : 5kV nominal

As number
As Ratio (10kV : 2kV)

Show Turns Ratio Show Voltage Ratio



8.1.4 Taps

As its forerunner, TR-MARK III provides tap changer control.

The following Screens show a transformer with a fully filled info field. If you do not fill it out, some shown information may not appear, but the screen keeps the same functionality.



NOTE

⇒ Please Check chapter '8.2.1.2 Taps' for detailed information about how to create a transformer with taps.

On the upper part of main screen, the actual tap step is displayed as a number. It is easy to measure through several or all tap steps. Besides are buttons, to switch one step up or down.

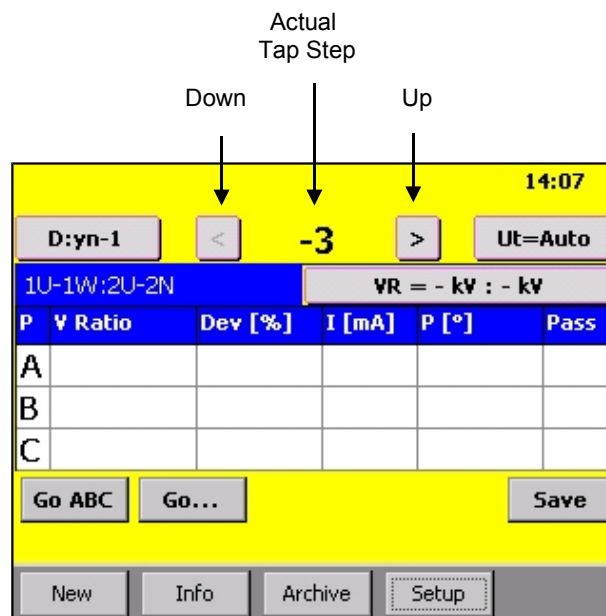

You may wish to know what for instance “tap 5” means in volts. Or you would like to switch to the 22kV Tap. Both can be done easily by touching the ‘Actual Tap Step Number’ (-3).

In the following window tap number and corresponding voltage is displayed. To give you an overview of all taps, a complete table with corresponding voltages is also available.



How to choose taps by nominal voltage:

The screenshot illustrates the process of selecting a tap based on nominal voltage. It consists of three overlapping windows:

- Top Window:** Shows a main interface with a tap value of **-3** circled in red. The secondary winding is labeled **secondary yn**.
- Middle Window:** A **Select Tap Changer** dialog box where the tap **-2 (9.800kV)** is selected and circled in red.
- Bottom Window:** A **Select Tap Changer Secondary** dialog box containing a table of available taps:

Name	U Nom [kV]
-3	9.7
-2	9.8
-1	9.9
0	10
+1	10.1
+2	10.2



8.1.5 More Taps

You may find Transformers with tap changers on primary and secondary winding system. TR-MARK III helps you to handle this too. Now let's see what happens, when we enter in chapter '8.2.1.2 Taps' a Transformer with taps on both sides.

The changeable tap step can be changed with '<' and '>' as described in chapter '8.1.4 Taps'. And too as described there, you can open a tap changer menu, by touching the displayed tap number. This menu is also used, to change the fixed tap step.



How to handle primary and secondary taps and nominal voltages:

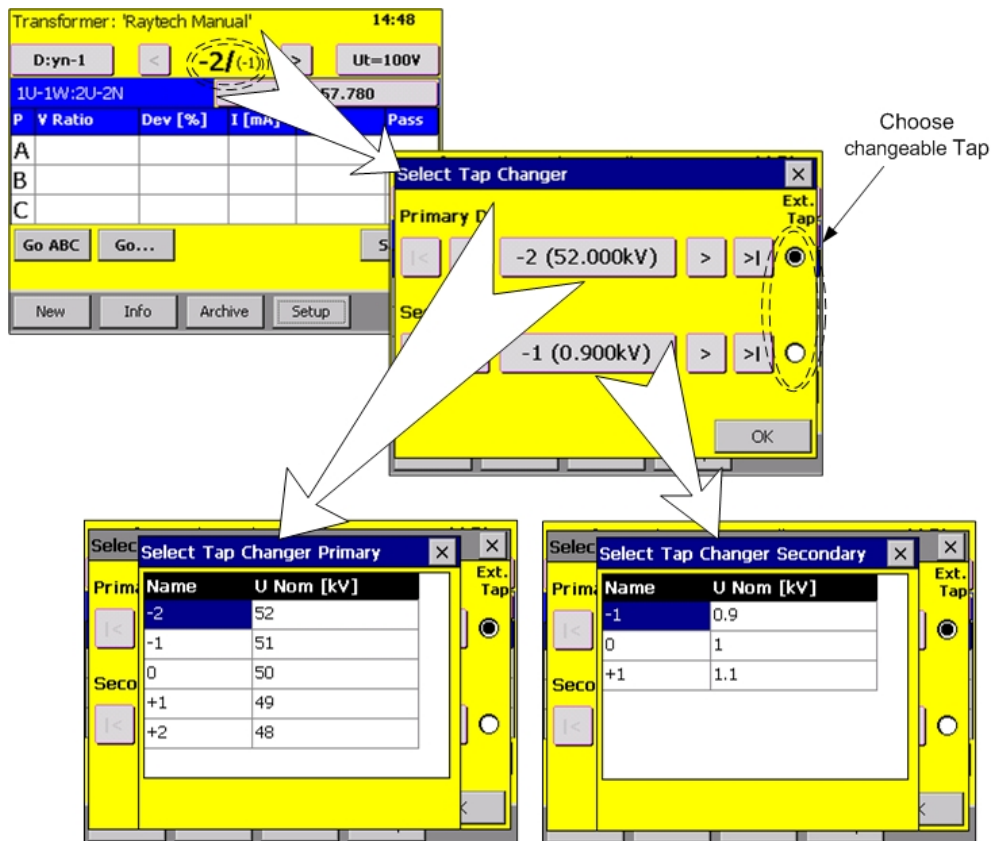



8.1.6 Tertiary Winding System



NOTE

⇒ Please Check chapter '8.2.1.3 Tertiary Winding System' for detailed information about how to create a transformer with three winding systems.

A really special transformer may have a primary, a secondary and a tertiary winding, and several taps on each winding. That's not a problem when you are using a TR-MARK III. A few buttons will give you control and overview over the complete measurement of such a transformer.

You may have asked yourself before, what the button on the upper left on main screen is used for. And why it is a button and not just a Text. The answer is in case of a tertiary winding system, it is used to switch between the ratio primary to secondary and primary to tertiary.

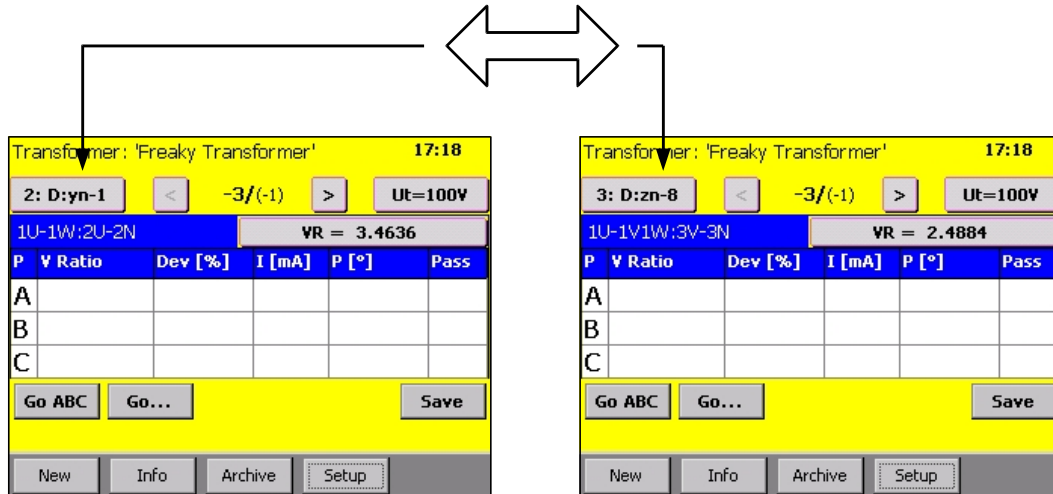

Also take notice of what happens with the tap changer display. As explained in chapter '8.1.5 More Taps', the fixed tap is displayed smaller and in braces, while the changeable taps appear bigger and bold. As you switch the X-Side from secondary to tertiary, the fixed tap changes too.



And now let's have a look how tap changer control works in this case.

Touch tap changer display as described in chapter '8.1.5 More Taps', and you will find yourself in front of the same screen.

The main difference is only the moment you switch to tertiary winding system.

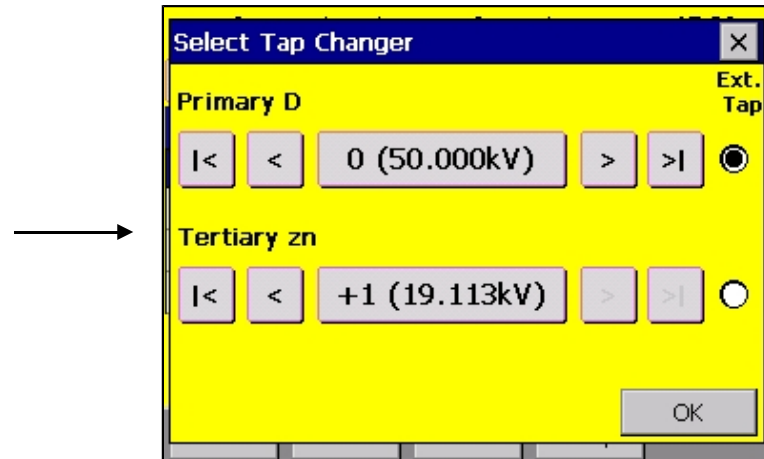

Of course you can too assign tertiary tap changer to be changeable. It is the same thing as with the secondary winding system.

Just be aware, that when you switch back to measure primary to secondary winding system, the tertiary tap changer is no longer relevant. TR- MARK III then automatically defines the primary tap changer to be changeable.



8.2 New

TR-MARK III offers an improved data structure and handling to support your needs. When the button 'New' in main screen is pressed, the user is asked what he wants to do by offering the four buttons showed below.



NOTE

⇒ Please Check chapter '7 Transformer, Measurement and Data Structure' for detailed information about data structure of MK III



8.2.1 New Transformer

This button will start the procedure of creating a new transformer. If the last used Transformer or measurement is not saved yet, you will be asked if you like to do so.

8.2.1.1 Simple Transformer, no taps

Then MARK-III sets the focus on the first winding system. Choose the type corresponding to your transformer from the menu shown below. MARK-III will accept it and set the focus automatically to the next input button.

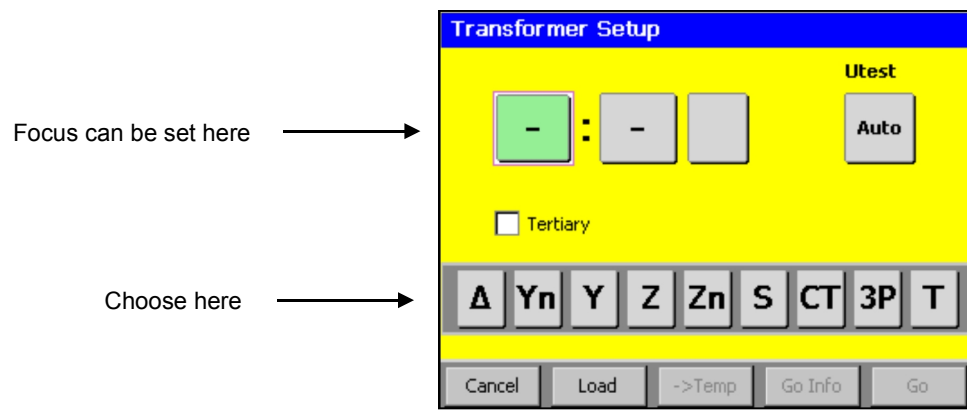

Touch the button below 'Utest' to choose your test voltage.

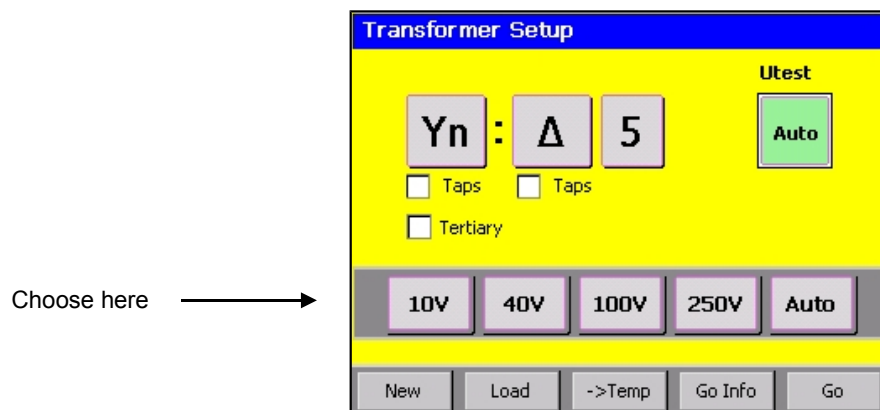

Finally, touch '**GO**' to get to main screen and start measurement.

Touch '**Go Info**' to get to main screen via Info menu, if you like to enter transformer details.

'-> **Temp**' will store the new transformer as a template. Please see chapter '8.2.5 Working with Templates' for detailed information.



8.2.1.2 Taps

For every winding system taps can be defined. Just touch the check box besides the text 'No Tap' below to the transformer coil where you want to enter taps. Then a screen to define tap steps appears.

Use '<' or '>' to increase or decrease first and last tap step.

tip here

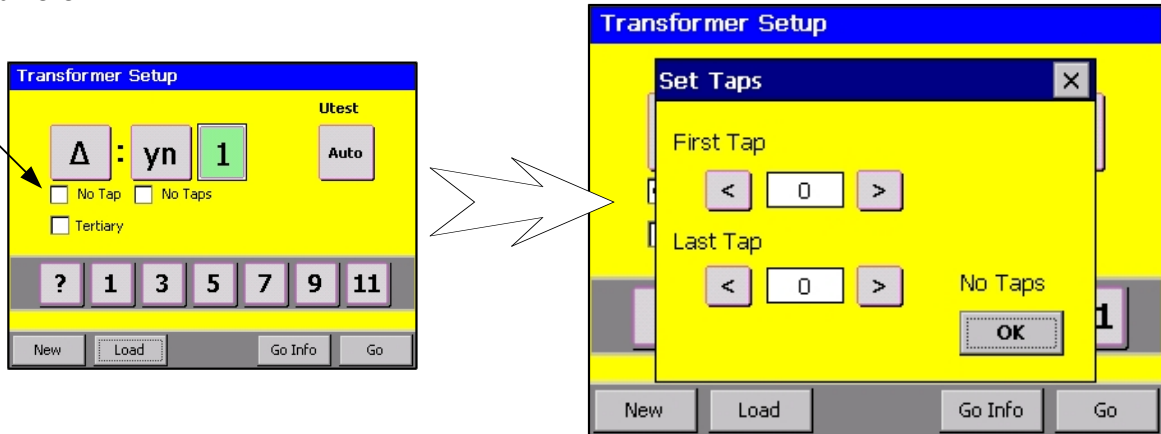

Press 'OK', and chosen taps will be displayed.

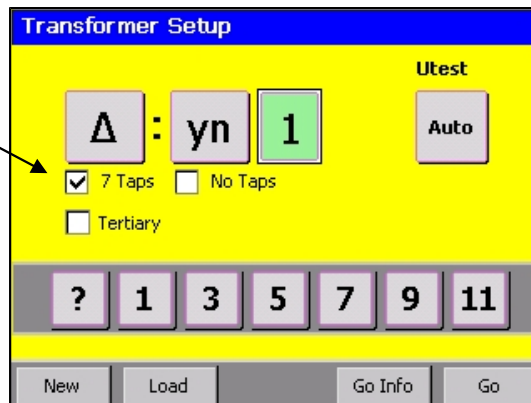

Your Transformer may have taps on the primary and on the secondary winding system. Use the same procedure to define the secondary taps.



NOTE

⇒ Please Check chapter '8.3.1 Enter Tap Changer Data by Wizard' for detailed information about how to assign voltages to tap steps



8.2.1.3 Tertiary Winding System

Don't worry about transformers with three winding systems. Just activate the 'tertiary' option, by touching the checkbox. Then the buttons for one more coil appears. And of course you can also define taps for this third winding system.

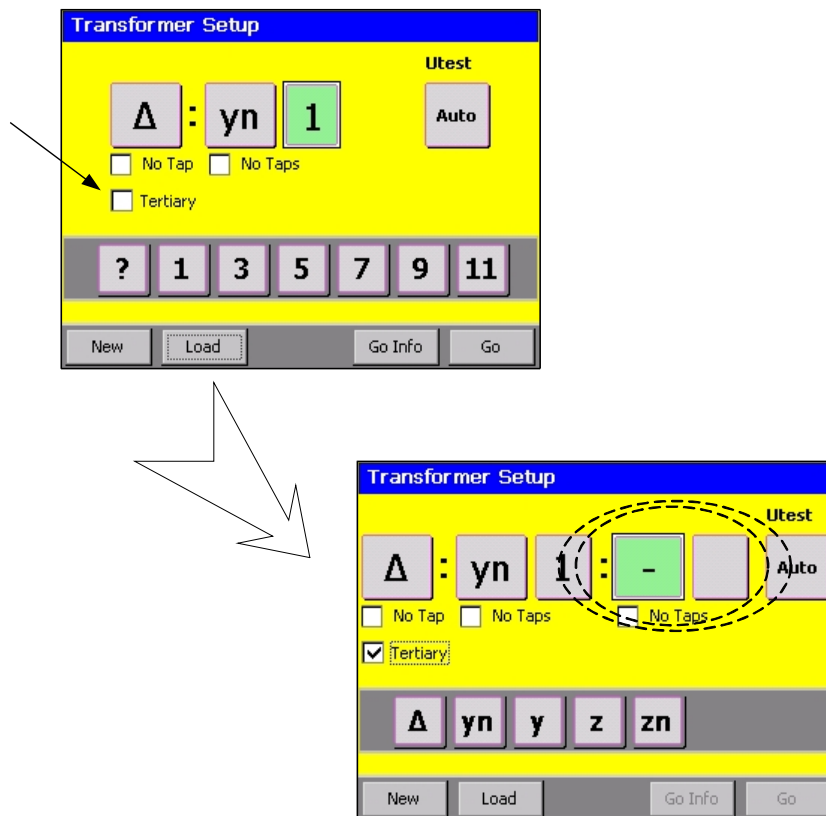



8.2.2 Load from Archive

You may already have stored the transformer you are up to measure on TR-MARK III or on a memory stick.

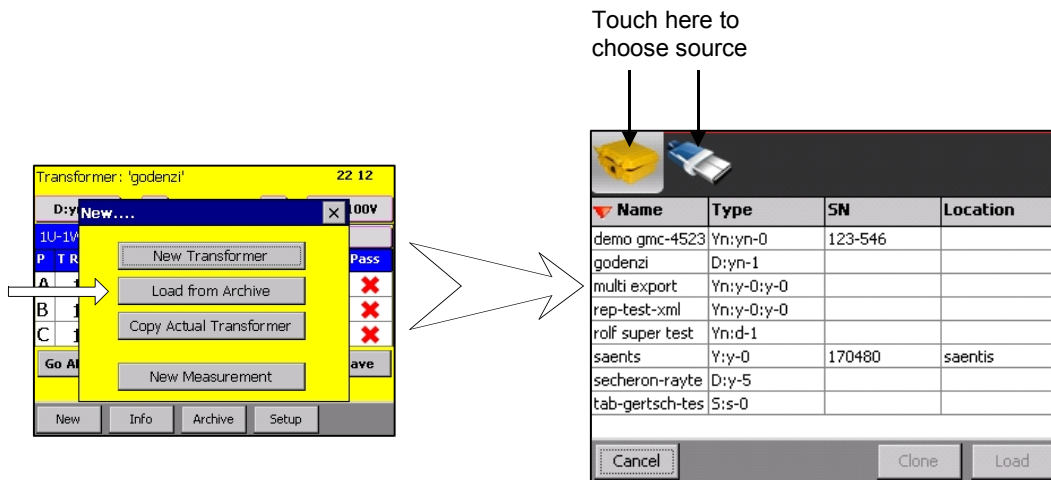

In the Archive screen, make your choice by touching on a transformer with your finger. Tap 'Load' to load it and append your measurement. Tap 'Clone' to create a new transformer, based on the one you have chosen.

Touch the pictures on top (MARK III or memory stick) to choose between the sources. The memory stick will only be displayed if connected.

If you are using a firmware version 3.0.97 or higher on a TR-MARK III 250V, profiles with 250V test voltage can be imported and exported as usual.

When using an older firmware version, or a common TR-MARK III, the test voltage of a 250V transformer profile will be reduced to an available voltage automatically.



NOTE

⇒ Test Voltage will automatically be changed, if you are importing a 250V transformer profile to a common TR-MARK III or if you are using a firmware version prior to 3.0.97



8.2.3 Copy Actual Transformer

Imagine you are a manufacturer of transformers or you are doing service and support. In both cases, you will often check identical objects. In this case we recommend you to use the “Copy Actual Transformer” option.

After tapping this button, TR-MARK III will copy the actual transformer basics, or lets say those things which don not change on transformers of the same type. In other words, a new transformer is created with the same number of winding systems, taps, winding types, and so on.

You will automatically be asked, if you would like to save the actual measurement if you did not yet do so. Afterwards you have to enter a new transformer name, serial number and if necessary new primary and secondary voltage. Or let’s say those things that change if you produce a further transformer of the same type.

If you are still a bit confused about it, have a look to the following screens and graphics including MK III screens.

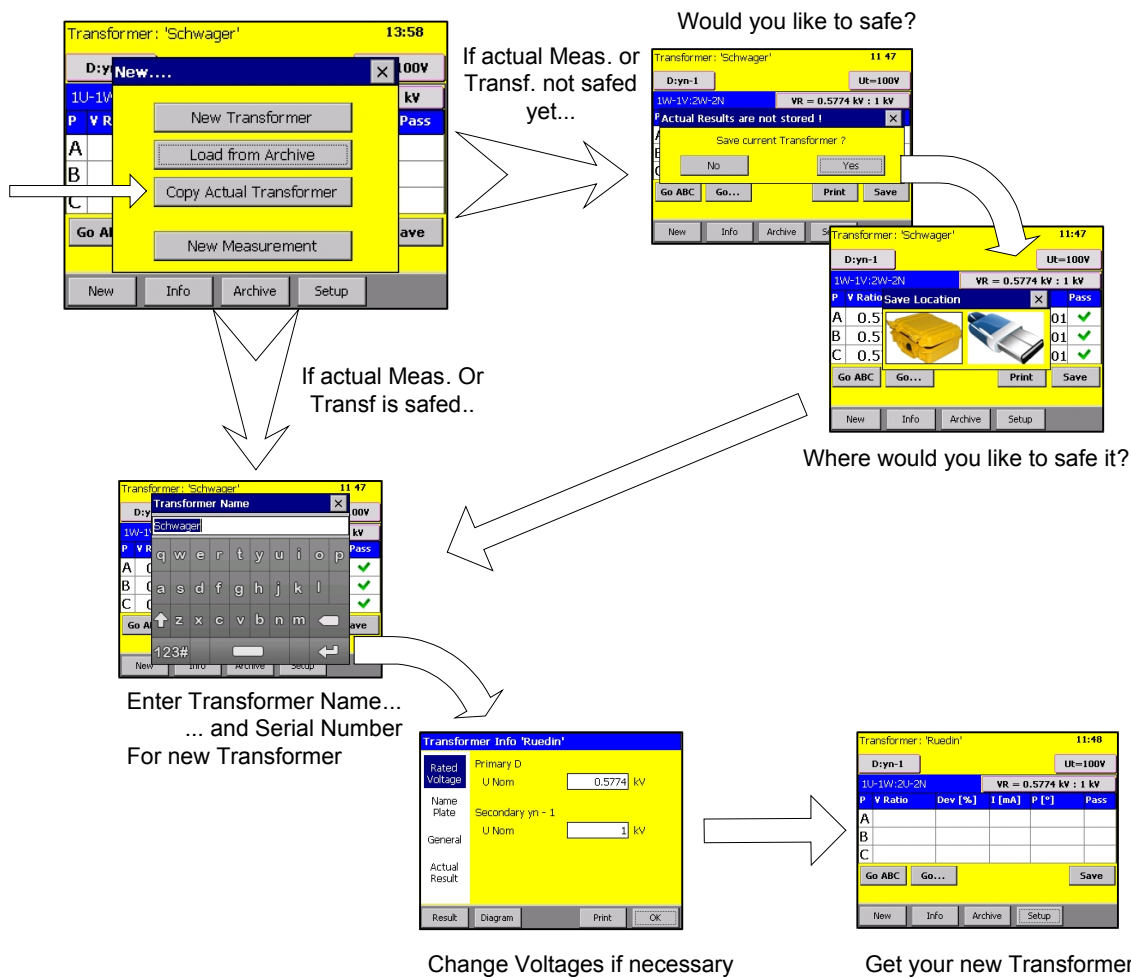



8.2.4 New Measurement

As described in chapter '7 Transformer, Measurement and Data Structure', TR-MARK III has only one measurement present at time. Starting the measurement process again, will result in overwriting the results on the screen. Tapping the 'save' button several time will have no effect

If you are up to do several measurements and save them, use the 'New Measurement' option.

You will be asked to save your present measurement, if you did not yet do so. Afterwards the results on screen will be erased. And after a new 'Go ABC' or 'Go...', you can attach further measurement to a transformer, by tapping 'save'.

8.2.5 Working with Templates

As described in Chapter '8.2.1 New Transformer', a new transformer profile can be created as a template. What does that mean?



NOTE

⇒ Use this option, if you have to measure many transformers of the same type.

The new profile will be created with a minimum of information, and it will be stored in the archive of TR-MARK III. In the info field 'serial number', 'Template' will automatically be entered, and you will be asked to give a Name to the transformer.

This Template can be cloned in Archive menu. Then TR-MARK III creates a transformer profile based on the template. You will be asked to enter a new transformer name and a serial number. After entering this information you will be led to main menu and measurement can directly be started.



8.3 Info

This screen has three goals:

- Helping the operator to identify Transformers
- Feeding TR-MARK III firmware with information, to improve its output.
- Viewing and printing of results

and it contains four sections. The sections are chosen by touching their name on the left side of the screen.

- **Rated voltage:**
Here primary and secondary, and if available tertiary voltage can be entered. MARK-III automatically calculates voltage and turn ratio based on these entries. Voltages on Tap changers can be defined manually or automatically by a wizard. See picture beside.

- **Add Info:**
This section especially helps to identify a transformer. Data like transformer name, serial number, manufacturer, type and so on can be entered and displayed.

- **General:**
Maximal Ratio Deviation can be set in this chapter. By default it is 0.5%. That means, if the measured ratio deviates more than 0.5% from the theoretical value, the measurement will be designated as "failed". Here you can also define which transformer standard is used. (IEC, ANSI, Australian)



- Results
A sorted List of results and graphics are available.



NOTE

⇒ Depending, if you start this screen from Archive or from Main Screen, and if you are the owner of a transformer, it will be read only or read/write.
When started from Main Screen, in chart 'Results' will be named as 'actual Result' and it will only show the actual result.



8.3.1 Enter Tap Changer Data by Wizard

Touch at 'Info' Menu the button besides "U Nom" to enter tap changer data manually or by wizard.

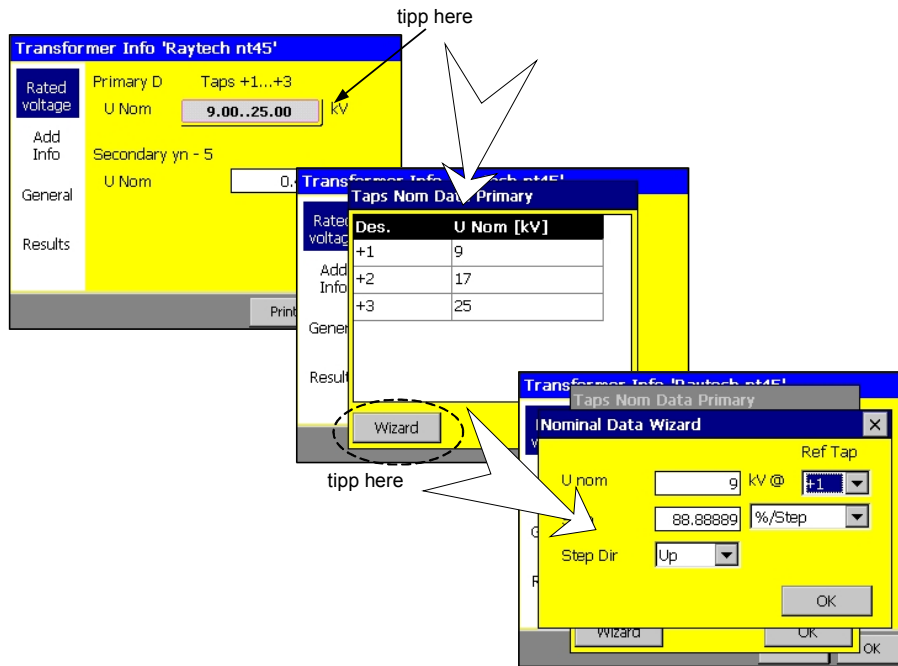

8.3.2 Enter Tap Changer Data manually

You can anytime enter corresponding voltages to taps manually. You may use this for instance when your tap steps are not linear. Just push on the filed you like to edit. The editor works for designator and voltage.

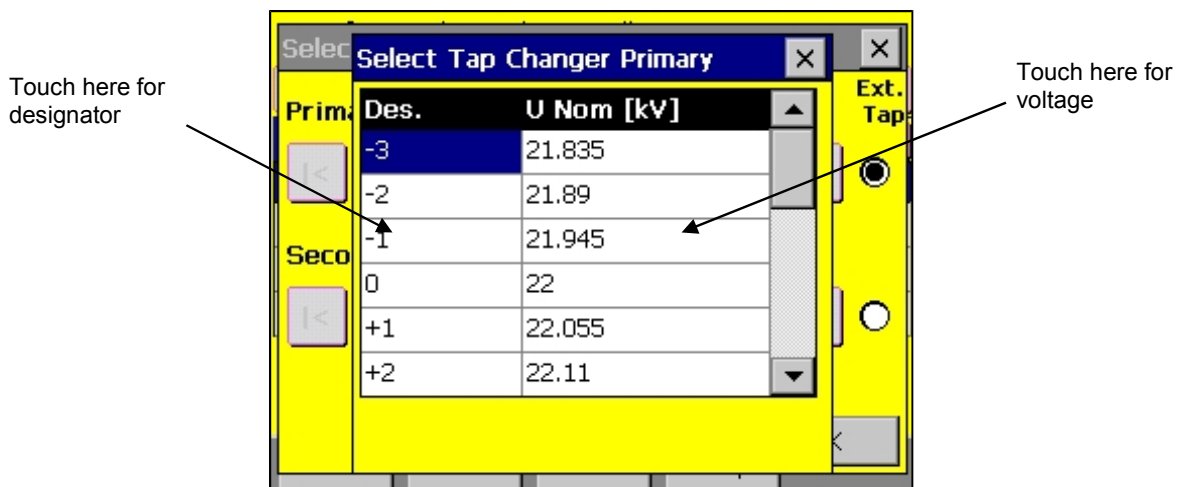



8.4 Archive

The 'Archive' menu is used to load, delete, import or export and show information of Data on TR-MARK III. Of course, the import and export feature can only be used, when a memory stick is connected to TR-MARK III's USB port.

No memory stick connected.

Name	Type	SN	Location
trex-GTR	3P:3p-0		
testllll	Yn:d-1		
Raytech nt45	D:yn-5	476345	
kkju	Yn:d-3:y-2		
demo gmc-4523	Yn:yn-0	123-546	
1/1/2000	Yn:yn-0		
1/1/2000	Z:yn-1		

Cancel Select All

Memory stick connected.
Touch here to switch to memory stick.

Name	Type	SN	Location
trex-GTR	3P:3p-0		
testllll	Yn:d-1		
Raytech nt45	D:yn-5	476345	
kkju	Yn:d-3:y-2		
demo gmc-4523	Yn:yn-0	123-546	
1/1/2000	Yn:yn-0		
1/1/2000	Z:yn-1		

Cancel Select All

Touch the lines to select one or several transformers.

As soon as one transformer is selected, it will be highlighted and function buttons in the bottom menu appear. If two or more lines are highlighted, 'Load' and 'Info' of course will disappear again.

Name	Type	SN	Location
trex-GTR	3P:3p-0		
testllll	Yn:d-1		
Raytech nt45	D:yn-5	476345	
kkju	Yn:d-3:y-2		
demo gmc-4523	Yn:yn-0	123-546	
1/1/2000	Yn:yn-0		
1/1/2000	Z:yn-1		

Cancel Load Delete Export Info

Selected Transformer

Function Buttons



8.5 Setup

Setup menu contains the following five parts:

- General
- Operators
- Standard
- Printer
- Colors

They can easily be selected with the symbol taps on top of the screen. The content of this five parts is described in the following chapters.

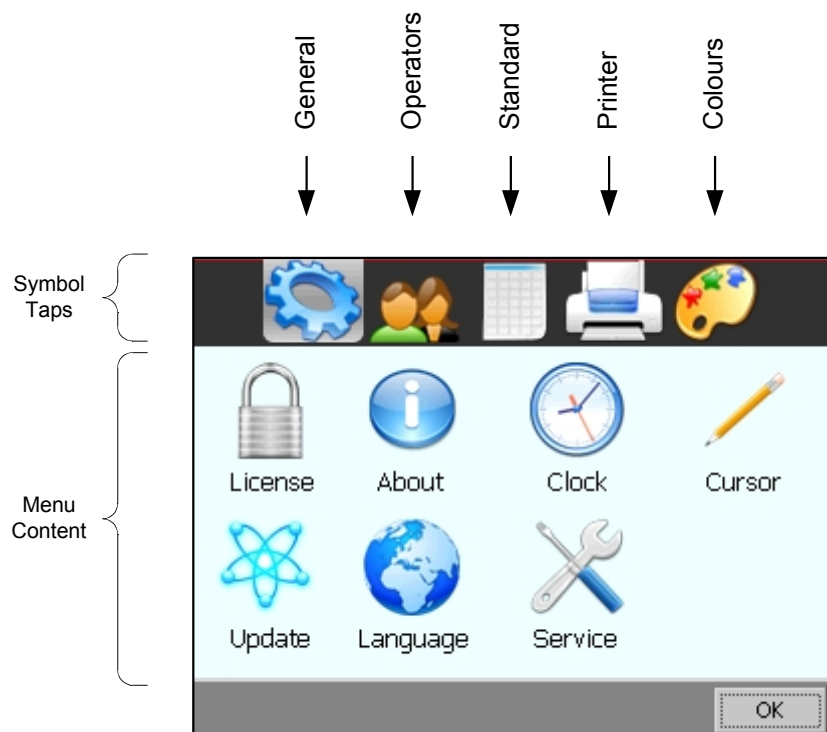



8.5.1 General



8.5.1.1 License

License Manger is used to enter a Raytech license number. If your license state changes, you may be asked to enter a new license.

This menu displays the actual license state. By touching the 'Enter New License Key' button, you can do so.

8.5.1.2 About

Choose this menu to get information about the instrument like firmware version and serial number.

8.5.1.3 Clock

Use this menu, to set date and time. This is important for your data sets, because your measurement will contain a time stamp.

8.5.1.4 Cursor

This option is important when using a USB mouse. Use it to switch cursor on and off.

8.5.1.5 Update

As Raytech GmbH always tries to increase comfort and quality of its products, sometimes firmware updates may be available. Usually they are just automatically installed, when connecting an USB memory stick with a new release on it.

In some cases it may be necessary, to initialize the update manually, especially if you are up to down grade to an older version.

Please see appendix '*D Firmware Update*' for details information and how to get firmware updates.

8.5.1.6 Language

TR-MARK III firmware supports several languages. Use this menu, to choose your favorite language from a list of all available languages.

8.5.1.7 Service

Qualified and especially instructed persons may have a service code, to get access to some special menu.



8.5.2 Operators



Every measurement can be stored with the name of the actual operator. In this menu, new operators can enter their first name and last name. Existing entries can be changed.

Touch an operators name and then touch 'ok' to make your choice.

Note the 'Ask for Operator at Powerup' check box. When checked, you will be asked if the chosen operators name is yours. This may be helpful, when several operators are using the same TR-MARK III.

8.5.3 Standards

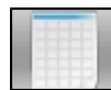

TR-MARK III supports several international transformer standards. Use this menu to choose the one you prefer.

8.5.4 Printer



If you are up to use an external USB Printer, you should choose the correct emulation. Connect your USB Printer to TR-Mark III's USB host connector³. Maybe you would like to print a test page, to make sure everything works properly.

To use the auto print option on the internal printer, choose this option in printer menu.

8.5.5 Color

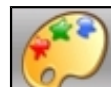

Two recommended color schemes are available. Indoor and in moderate sunlight you may prefer the colored scheme.

In bright sunlight black and white provides maximal contrast to make sure everything remains readable.

³ The USB host has an oblong connector, USB device has square connector.



9 Technical Specification

Features

- Automatic measurements of voltage ratio, turns ratio, current, and phase displacement
- Turns ratio range 0.8 to 16000⁴
- Easy one time hook up to the transformer
- Automatic test voltage range
- Displays deviation from a nominal ratio
- Graphical tap changer display
- Tap changer interface (In- and Output)
- Load on test object <0.05 VA
- Measures power transformers PT's and CT's
- Displays % error vs. name plate value
- Automatic phase vector detection
- Enhanced heavy-duty protection circuitry
- Extremely rugged (withstands a drop test of 1 meter)
- Data exchange via USB
- Firmware update with USB key
- Internal Printer

Measurement Parameters

Ratio

Resolution: 5 Digits

U_{test}	Range	Accuracy	
250V	0.8 ... 5000	±0.06%	Rdg ±1 LSD
	5001 ... 10'000	±0.1%	Rdg ±1 LSD
	10'001 ... 32'500	±0.3%	Rdg ±1 LSD
	32'501 ... 40'000	±0.4%	Rdg ±1 LSD
100V or 40V	0.8 ... 2000	±0.06%	Rdg ±1 LSD
	2001 ... 4000	±0.1%	Rdg ±1 LSD
	4001 ... 13000	±0.3%	Rdg ±1 LSD
	13000 ... 16000	±0.4%	Rdg ±1 LSD
10V	0.8 ... 500	±0.1%	Rdg ±1 LSD
	501 ... 1000	±0.12%	Rdg ±1 LSD
	1001 ... 3250	±0.3%	Rdg ±1 LSD
	3251 ... 4000	±0.4%	Rdg ±1 LSD
1V	0.8 ... 50	±0.1%	Rdg ±1 LSD
	51 ... 100	±0.15%	Rdg ±1 LSD
	101 ... 325	±0.3%	Rdg ±1 LSD
	326 ... 400	±0.4%	Rdg ±1 LSD

⁴ 250V up to 40'000



Current

Resolution: 0.1 mA

U_{test}	Range	Accuracy
250V	0 ... 400mA	±1 mA

U_{test}	Range	Accuracy
1V to 100V	0 ... 1A	±1 mA

Phase Angle

Phase Range: ±90 Degree, Resolution: 0.01°

U_{test}	TR-Range	Accuracy
250V	0.8 ... 600	±0.05°
	601 ... 5000	±0.10°
	5001 ... 10'000	±0.15°
	10'001 ... 32'500	±0.40°
	32'501 ... 40'000	±0.50°

U_{test}	TR-Range	Accuracy
100V	0.8 ... 240	±0.05°
	241 ... 2000	±0.10°
	2001 ... 4000	±0.15°
	4001 ... 13000	±0.40°
	13000 ... 16000	±0.50°

U_{test}	TR-Range	Accuracy
40V	0.8 ... 240	±0.10°
	241 ... 2000	±0.15°
	2001 ... 4000	±0.20°
	4001 ... 13000	±0.45°
	13000 ... 16000	±0.55°

U_{test}	TR-Range	Accuracy
10V	0.8 ... 60	±0.15°
	61 ... 500	±0.25°
	501 ... 3250	±0.55°
	3251 ... 4000	±0.65°

U_{test}	TR-Range	Accuracy
1V	0.8 ... 6	±0.15°
	7 ... 50	±0.25°
	51 ... 325	±0.55°
	326 ... 400	±0.65°



Specifications

- Input power: 100 to 250 VAC 50/60 Hz auto ranging, Fuse: 2AT
- Test Voltage User Selectable: 100, 40, 10, and 1VAC
- Max test current: 1A
- Panel Display Color LCD (5.7") with back lighting and touch screen
- Front Panel Sealed, Anodized
- Interfaces: USB 2.0 (1 host /1 device) and RS232 serial 9 Pin
- Memory Storage Internally stores more than 10 000 test results
- Temperature: Operating -10°C to 60°C , Storage: -20°C to 70°C
- TR-MARK III:
L: 470 mm (18.5") W: 371 mm (14.6") H: 190 mm (7.5") Weight: 9.5 kg (21 lbs.)
- TR-MARK III R 19", 4U rackmount version:
L: 490 mm (19.3") W: 436 mm (17.2") H: 177 mm (7") Weight: 7.8 kg (17 lbs.)

Accessories

- Complete cable set of 5 m (16.4 ft) cable with an extension cable of 10 m (32.8)
- Cable carrying bag, instruction manual, software for data download

Options

- Extended safety interlock
- TRO-203 external test switch for Tap changer testing
- T-REX 3-phase Supply to energize all 3 phases at once

* Specifications are subject to improvement at anytime



10 Interfaces

10.1 Hardware

1 x RS232, 9 Pin



Pin 2 TxD (TR-> Host)
 Pin 3 RxD (Host-> TR)
 Pin 5 GND

Interface Parameters:
 (fix, not changeable)

Port RS232
 Baudrate 19200Baud
 Databit 8 Bit
 Stopbits 1 Bit
 Parity No

1 x T-Rex Extension

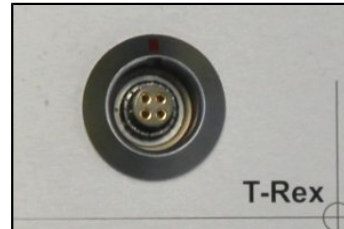

Pin 1: trex_D0
 Pin 2: trex_D1
 Pin 3: trex_Busy
 Pin 4: GND

1 x USB-Host 1 x USB Device

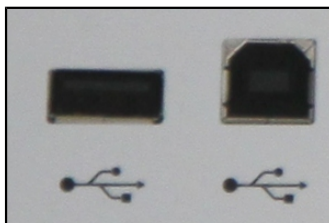

USB 2.0
 Standard type A and B

Extern / Tap Switch

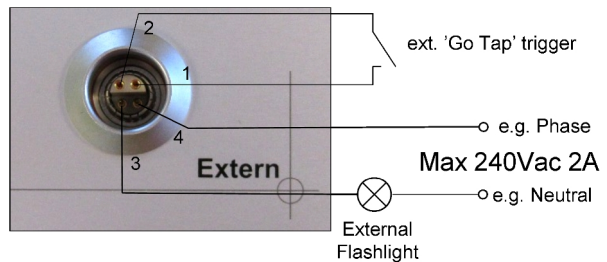

example for **external warning device**

TR-MARK III offers 1 relay contact between Pin 3 and Pin 4.
 Pin 1 & 2 is the Tap Changer input. Shorten those two pins by a working contact to start measurement when using 'Go Tap'.



10.2 T-Base (Software)

more information on www.raytech.ch or tbase.raytech.ch

Description

T-Base Pro is a powerful tool to remote control Raytech test instruments, data exchange and analyse measured data of it. It runs on every windows based PC and a modern graphical user interface makes it easy and a pleasure to operate. Any custom request or special feature can easily be added with a custom Add-On.

Example

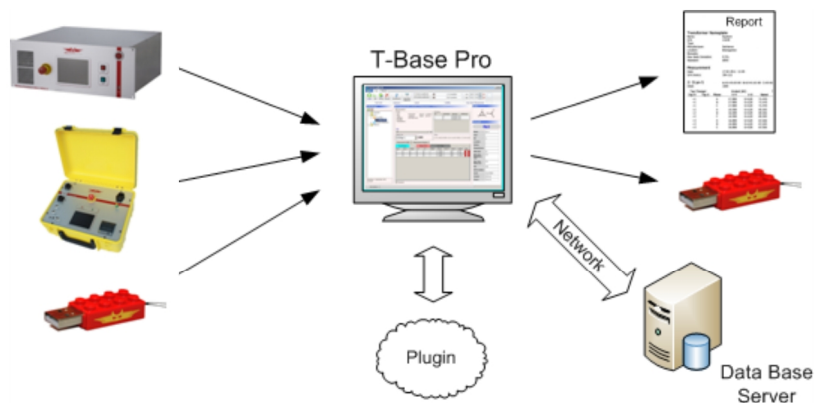

Advantages & Features

- Import transformer name plate data and measuring results from devices by USB with a few clicks
- Generate transformer name plate data sets on your PC and export them to devices
- View measurement data in a table or diagram
- Control devices by remote (option)
- Generate, save and print test reports
- Store all your data in one database ordered by transformers, not by measuring method
- Use powerful search functions to find your measurements quickly
- Work with a clearly arranged user interface
- Easily integrate individual software plug-ins to expand the T-Base Pro to what ever you need.

Specifications:

- Operating Sys.: Min. Win XP, SP3
Win Vista or 7
- Hardware ≥ Pentium 4, 3.2GHz,
1GB Ram
Core2 recommended
- Min. Screen: 1024 x 768 pixel
Recommended: ≥ 1360 x 768 pixel

Included in Delivery

- Native Raytech USB Driver
- Documentation

Options

- Database located on server
- Synchronize with external server



10.3 TR-MARK III USB Device Interface



NOTE

⇒ For an quick and easy use of the USB Device Interface for remote control, we recommend Raytech Toolbox or SDK (Software Development Kit)



NOTE

⇒ TR-MARK III uses the same command set on USB port and on serial interface.

10.3.1 Hardware Protocol

TR-MARK III provides a standard USB interface containing Standard A and B plugs for host and device applications.

For detailed information about the USB protocol, please visit www.usb.org

10.3.2 Raytech Native USB Driver

The low level communication is done by Raytech Native USB Driver. If it is properly installed, the user does not have to care about Windows recognizing TR-MARK III on a USB port. Raytech devices that are switched to Raytech Driver Mode with service code 2001, will register themselves to a Microsoft operating system.

You can get and use Raytech Native USB Driver by installing the latest version of Raytech Toolbox or using Raytech SDK (Software Development Kit) for remote control.



NOTE

⇒ Required firmware version 3.1.1.0 and later. Do not use former Versions for Remote Control, updates at www.raytech.ch



10.3.3 Software Protocol

10.3.3.1 When using Raytech Toolbox

The user of Raytech Toolbox does not have to care about protocol and commands. The device can be fully operated by a graphical user interface.

10.3.3.2 When using SDK (Software Development Kit)

Raytech Native USB Driver provides many embedded commands, that can easily be used within a .NET language. C# is recommended. Any other command can be sent with the `driver.send()` or `driver.sendAndReceive()` command.



NOTE

⇒ TR-MARK III uses the same command set on USB port and on serial interface.

For detailed information, please see chapter '10.4.2 Software Protocol', document '90101-0.05 Command Set TRMarkIII.pdf' or contact Raytech Switzerland or your local vendor.



10.4 TR-MARK III Serial Communication Interface



NOTE

⇒ TR-MARK III serial interface is designed to work properly with the same hardware and command set as TR Spy II.
Commands that are not used on TR-MARK III will return 'ok' as Answer.

10.4.1 Hardware Protocol

- 9 pole D-Sub
- Pin 2 TXD Data TR to Computer
- Pin 3 RXD Data Computer to TR
- Pin 7 GND
- +/- 12 V Signals

Protocol: 19200 Baud, 8 Bit, 1 Stop bit, no parity

10.4.2 Software Protocol



NOTE

⇒ Required firmware version 3.1.1.0 and later. Do not use former Versions for Remote Control. Call us for updates.

10.4.2.1 Switch to Remote

The Device is switched to REMOTE by:

- Command "RM"
- Every command which is executing a measurement (MA,MB,MC,MF)

10.4.2.2 Switch to Local

With Command SL (Set to Local) or with the Local Button on the display. This button will be the only object on screen in remote mode until it is pressed, or 'local' command is sent.



10.4.2.3 Syntax of Commands

„cc [Data1[;Data]..]CR

cc = 2 ASCII Character for the Command

‘;’ (semicolon or space) Separator for multiple Data fields

Numeric Format of Numbers: float (C - Language), “.” as decimal point

Format of Strings: all ASCII Characters from 0x20 to 0x7f

Terminator: „CR“ (= 0x0D) or LF (0x0A)

Answers without data

*0 ok ok

*1 unkn Syntax Error

Answers with data

xx,Message1[,Message2;[Message3]..]“,CR

xx Type of answer (the command itself)

10.5 TR-MARK III Remote Commands

Please visit www.raytech.ch or contact your local representative or Raytech Switzerland for a complete and actual command set.



Appendix

Turns Ratio Meter 3 Phase Type TR-MARK III



Raytech GmbH
Oberebenestrasse 11
CH 5620 Bremgarten
Switzerland



Contents

A.	Application Notes.....	57
A.A	Real Three Phase Voltage Option T-Rex.....	57
A.B	Current Transformer Testing.....	58
A.B.A	Introduction.....	58
A.B.B	Usual Measurement.....	58
A.B.C	Low Impedance.....	59
A.B.D	Info.....	59
A.B.E	CTs with Taps (Tapped Secondary).....	59
B.	Test Reports.....	60
B.A	Internal Printer.....	60
B.B	External Printer.....	61
C.	Extended Safety Interlock Option (70049-A).....	62
C.A	A Look under the Hood.....	63
C.B	Dummy Plug – Use without external Interlock.....	63
D.	Firmware Update.....	64
E.	Error Messages.....	65
F.	Warranty Conditions.....	66
G.	Trouble Shooting.....	67
H.	Contacts.....	67



A. Application Notes

A.A Real Three Phase Voltage Option T-Rex

The Raytech Real Three Phase Voltage Option T-Rex is an optional system accessory for 3-Phase transformer ratio meter test sets designed by Raytech (i.e. TR-MARK III).

T-Rex was designed to allow Engineers and Test Technicians the ability to test the phase relationships and actual voltage ratios of transformer windings while applying three phase voltage.

The system can precisely measure the ratio and angular relationship of transformer phases with voltage applied to all three phases simultaneously. This is a “real condition” measurement, which allows greater understanding of how the transformer will operate connected to a 3 phase system.

The T-Rex is especially useful for transformers with:

- Phase relationships other than 30°.
- Zig Zag windings.
- Uncentered neutral points.
- Suspected broken, damaged, or missing core laminations.

The T-Rex is contained within a separate yellow case and comes complete to connect to the Raytech TR-Spy MARK II or TR-MARK III three phase transformer ratio meter.

T-Rex connected to TR-MARK III, ready for operation:





A.B Current Transformer Testing

A.B.A Introduction

Current transformers are, in effect, opposite wound voltage transformers. This basically means that the largest number of windings are on the “X” (low current) side of the current transformer.

The TR-MARK III applies a voltage (from 1 to 100 VAC) from the “H” leads and measures back through the “X” leads. The “X” leads always must have a lower voltage than the “H” leads or an error will be displayed. Therefore, when testing Current transformers the “H” test leads are connected to the “X” terminal of the Current Transformer.



NOTE

⇒ For CT testing, “H” leads are connected to the “X” terminal of the Current Transformer.

A.B.B Usual Measurement

Connect the test leads as shown. For the highest accuracy, create a new transformer and select CT. Use 10V to start. Use 40V test voltage for very big ratios only.

CT is selected for Current Transformers exclusively. This test set has a special Voltage / Current function built-in for Current Transformers. If an error is still present after using 10V, use test voltage 1V.

1. Connect Current Transformer as followed:

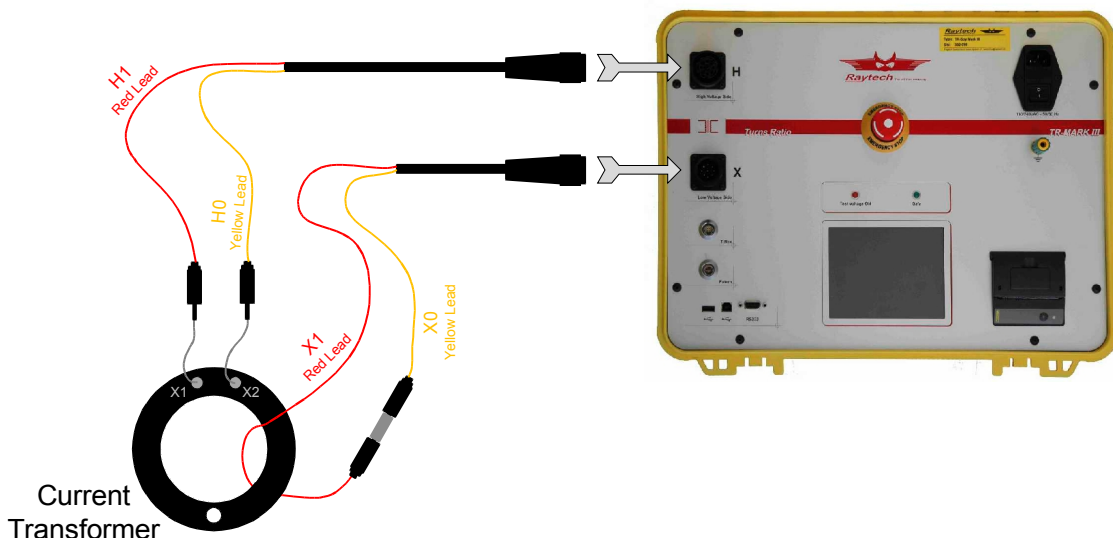



2: Select CT Testing, use 10 (normal),
40V (high ratio) or 1V (low impedance)

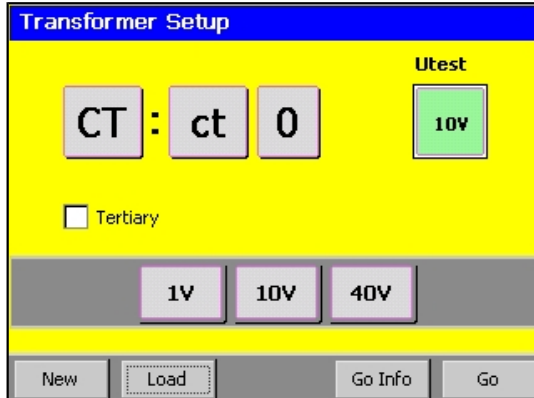

3: Touch Go A

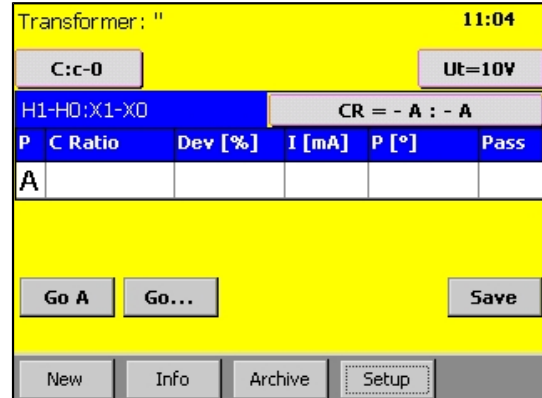

A.B.C Low Impedance

In certain cases, where the impedance (inductance) of the CT is so low that TR-MARK III gets to its power limits, an "Overcurrent" Message will be displayed on the screen. It is then recommended to run the test with a lower test voltage.

A.B.D Info

Of course the ratio in the info field for CTs is defined by Amps / Amps. (Not Volts / Volts as it is used for voltage transformers. The rest of the 'Info' screen remains the same.

A.B.E CTs with Taps (Tapped Secondary)

Current transformers with multiple secondary taps are tested similar to single secondary taps. After each specific ratio is tested the H1 (or H0) lead can be moved to the next position and that ratio can then be tested.

In addition to the previous test the secondary of the CT can be tested like an auto transformer.



B. Test Reports

Test Reports are printed results of TR-MARK III. The following two chapters show test reports.

Please see chapter '8.1.2.3 Print and Save, Turns Ratio or Voltage Ratio' about how to print. To use the external instead of the internal printer, just connect a printer to USB port of TR-MARK III.

B.A Internal Printer

Test				Report		
by Raytech TR Mark III						
Transformer						
VG : D:yn-5						
Name: Raytech						
Type:						
S/N : 21649						
Loc : Bremgarten						
Rem :						
Std : ANSI						
Measurement						
S/N: 304-112						
Date: 17.02.2011						
Time: 12:05						
Oper:						
2 : D:yn-5						
Utest: 100V						
P	S	Ph	TRatio	Dev [%]	I [mA]	P [°]
+1	0	A	71.475	0.01	0.4	+0.01 P
+1	0	B	71.495	0.04	1.1	+0.01 P
+1	0	C	71.475	0.01	0.3	+0.01 P
+2	0	A	69.355	-0.02	0.5	+0.01 P
+2	0	B	69.375	0.01	0.9	+0.01 P
+2	0	C	69.360	-0.01	0.4	+0.01 P
+3	0	A	67.250	-0.02	0.5	+0.00 P
+3	0	B	67.265	0.00	1.1	+0.01 P
+3	0	C	67.250	-0.02	0.4	+0.01 P



B.B External Printer



***** Test Report *****

Transformer Nameplate

Name: Rolf-Secheron
 S/N: 21649
 Type: NT 32.440
 Manufacturer: Secheron
 Location: Bremgarten-West
 Remarks:
 Max Ratio Deviation: 0.5%
 Standard: ANSI

Configuration

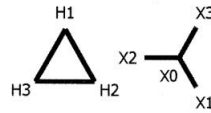

Measurement

Date: 21.02.2012 16:08
 S/N Device: TR MARK III 304-121

1:2 Δ:Yn-5

Utest: 100V / A:H1-H3:X3-X0 B:H2-H1:X1-X0 C:H3-H2:X2-X0

Tap Changer		Phase	Urated [kV]		Turn Ratio			Itest[mA]	Angle [°]	Pass
Tap H	Tap X		U H	U X	Rated	Acutal	Dev [%]			
1		A	17.000	0.4120	71.470	71.500	0.05	0.8	+0.00	True
1		B	17.000	0.4120	71.470	71.485	0.02	0.1	-0.01	True
1		C	17.000	0.4120	71.470	71.480	0.02	0.0	-0.01	True
2		A	16.500	0.4120	69.365	69.395	0.04	0.7	-0.01	True
2		B	16.500	0.4120	69.365	69.380	0.02	0.1	0.00	True
2		C	16.500	0.4120	69.365	69.385	0.02	0.0	0.00	True
3		A	16.000	0.4120	67.265	67.295	0.04	0.9	-0.01	True
3		B	16.000	0.4120	67.265	67.240	-0.03	0.2	-0.02	True
3		C	16.000	0.4120	67.265	67.280	0.02	0.0	-0.02	True



C. Extended Safety Interlock Option (70049-A)

With this option Raytech provides the possibility to connect an external safety switch or interlock line. For instance door contacts of a safety fence or a 'high voltage off detector' could be connected.

The pins of the Extended Safety Interlock are placed on the extern connector. A device with this option can be recognized by having a 6 pin Lemo 'Extern' connector. Please see chapter '5.1' and '6.2' to locate this plug. A standard TR-MARK III version has a 4 Pin connector as described in chapter '10.1'

Pin definition:

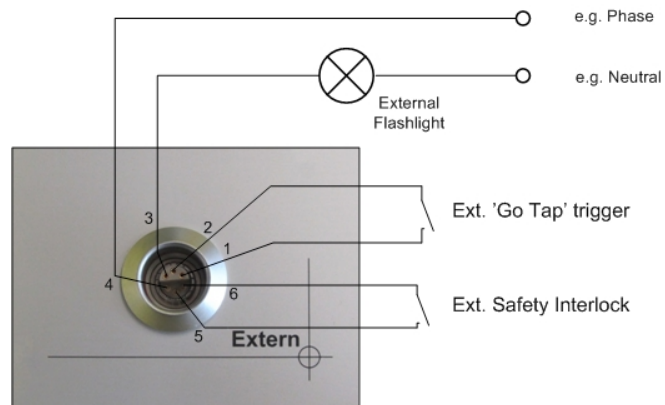



C.A A Look under the Hood

The Extended Safety Interlock is nothing else, than the access to the internal safety interlock of TR-MARK III. An open external interlock line will have the same effect to the device as a pressed emergency switch. Please see the following schematic as an additional explanation:

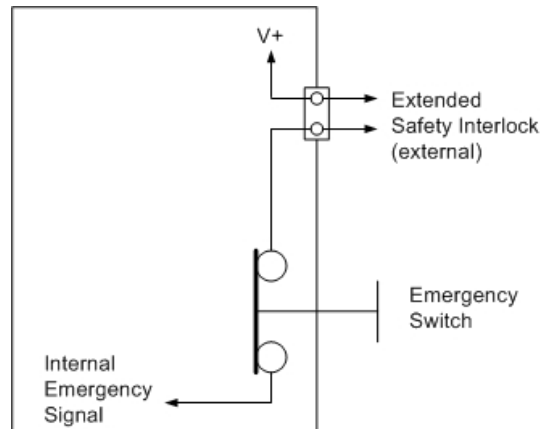

Of course, when using an 70049-A device that is not connected to an external interlock line, the use of a dummy plug is necessary.

C.B Dummy Plug – Use without external Interlock

As visible in 'C.A A Look under the Hood', the Extended Safety Interlock has to be bridged when it is not used. Other vice TR-MARK III will show the 'emergency pressed' message and remain in a safe mode.

The Dummy Plug shown below is delivered with every Extended Safety Interlock option.





D. Firmware Update

As Raytech GmbH always tries to increase comfort and quality of products, sometimes firmware updates may be available. Ask your local vendor, or visit our website www.raytech.ch and have a look for new firmware releases.

Once you have downloaded from the website your file containing a new version, copy it to the root directory⁵ of a USB memory stick. Then connect this stick to your TR-MARK III. Usually the new firmware release will be detected and you will be asked if you like to install it.

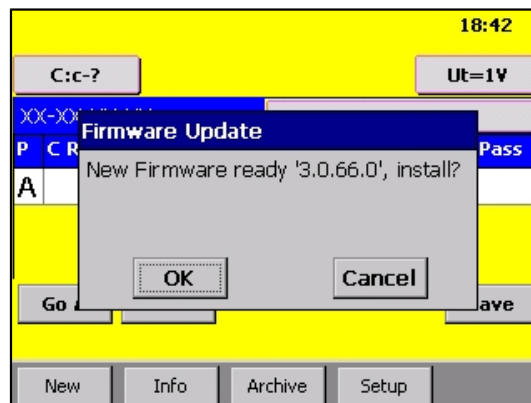

In some cases, for instance if you like to downgrade to an older version, you will have to start the installing process on your own. See the graphics below or see chapter '8.5.1.5 Update' for detailed information how to do this.

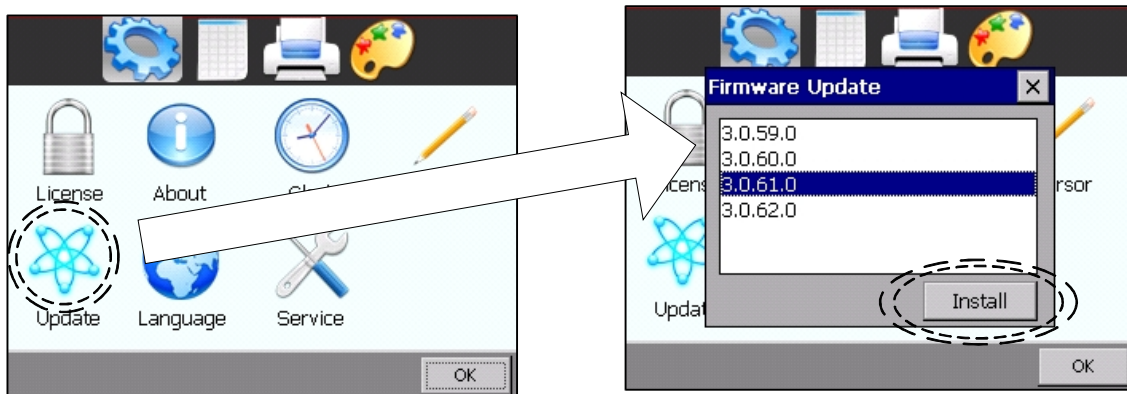

WARNING!

⇒ DO NOT TURN DEVICES OFF DURING A RUNNING UPDATE PROCESS.

⁵

root means no subfolder, directly to the stick



⇒ DO DISCONNECT USB MEMORY KEY DURING A RUNNING
UPDATE PROCESS



E. Error Messages

TR-MARK III is designed to be trouble free, so you may not see many error messages. A few messages appear because of operation error. Let's have a look at those first.

<u>Message</u>	<u>Explanation</u>
No Test Leads:	TR-MARK III will find out if no test leads are connected, or if they are not connected to test object. This message may save time during measurements in the field.
Emergency Pressed:	No measurement is started when emergency switch is pressed, a running measurement will be cancelled immediately. Release emergency switch, and this message will disappear.
Check Trafo Setup:	In many cases an incorrect connected test object is detected by TR-MARK III. Then this message appears.
TRex not found:	You will see this message, when trying to measure with a T-Rex which is not connected.
3P:3P only with Voltage Ext:	Another message, that may appear when trying to start a T-Rex measurement without having it properly connected
Overcurrent:	As the message says, a too high current is flowing on the H side. Check test setting, and all connections.

Other messages may appear because of damage or malfunction of a component of TR-MARK III. If one of those messages appear, switch TR-MARK III off. Restart it after a few seconds and try again. If you are still facing the same message, please contact our local representative or call Raytech Switzerland.

- Calibration failed
- Calib Warning
- ADC Quarz failed
- No Sync
- No Com
- H8Reset
- Comm Lost
- Kennzahl,{0},{1}
- Relais,{0},{1}
- Voltage
- TRex
- Phase
- Trafo,"Kennzahl
- Tap Switch



F. Warranty Conditions

Raytech GmbH Switzerland shall at their option and expense, repair, replace or newly provide any parts or services that prove to be defective within the warranty limitation period-irrespective of the operating time of the test equipment provided that the cause of the defect occurred prior to the time at which the risk was passed.

Warranty claims are subject to a warranty limitation period of 24 months from the date of shipment.

The purchaser is obligated to immediately notify Raytech GmbH Switzerland in writing form of any defects of the supplied test equipment.

Raytech GmbH Switzerland must always be given the opportunity to rectify a defect within a reasonable time. The purchaser shall grant an adequate time within the test equipment shall be repaired.

Raytech GmbH Switzerland covers the costs associated with the repair of the defect.

Especially the costs for the material and work. Cost for sending the faulty test equipment shall be borne by the purchaser. Raytech GmbH Switzerland shall not be liable for material damage, or financial loss due to the loss of production, loss of data, loss of information, data or interest, regardless of their legal basis.

Warranty claim rights on replacement parts as well as repair of defective parts shall expire after 12 months.

Warranty limitation period shall be extendable according to the price list. The purchaser has the right to extend the warranty period by purchasing additional warranty years.

Limitation of Warranty

The foregoing warranty shall not apply to defects resulting from improper and unauthorized modifications or misuse and abuse of the product, negligence, alteration, modification, faulty installation by the customer, customer's agents or employees. Attempted or actual dismantling, disassembling, service or repair by any person, firm, or corporation not specifically authorized in writing by Raytech GmbH Switzerland.

Defects caused by or due to handling by carrier, or incurred during shipment, trans-shipment, or other move. Inadequate maintenance by the customer, second source supplied software or interfacing, operation outside the environmental limits, or improper site preparation.

Exclusive remedies provided herein are the customer's sole and exclusive remedies.

Raytech Switzerland shall not be liable for any damages resulting from the use of this equipment whether direct, indirect, special, incidental, or consequential damages, or whether based on contract, tort, or any other legal theory.

NO OTHER WARRANTY IS EXPRESSED OR IMPLIED.

Arbitration

All disputes arising out of or in connection with the contract between the purchaser and Raytech GmbH Switzerland and including those regarding the legal validity of this contract and this arbitration clause shall be settled out of court and shall be referred to arbitration for final decision.

Any disputes between the purchaser and Raytech GmbH Switzerland shall be settled according to the rules of settlement and arbitration of the chamber of commerce in Zurich by one or more arbitrators appointed also according to the rules of arbitration of the chamber of commerce in Zurich Switzerland.



G. Trouble Shooting

System does not display anything:

1. Check the display for any Initialization.
2. Check the fuse. The fuse is located in the Power switch / plug connector. Please see chapter '5.1 Front Panel Overview'. You will find it at position 1.

Touch Panel does not work:

Please connect any USB mouse to the USB port on the front panel TR-MARK III will display a cursor and everything can be done by mouse. Please see chapter '8.5.1.4 Cursor' if cursor is not automatically displayed.

Measurement can not be started:

Is the Emergency stop switch pushed in? Turn to release it.

USB Memory Stick does not work:

There are a few unsupported memory sticks available on the market. Please use another model and try again.



NOTE

⇒ TR-MARK III is designed to be trouble free.
If problems or questions do arise please contact your nearest representative or our service support group in Switzerland.

H. Contacts

Raytech Switzerland

Raytech GmbH
Oberebenenstrasse 11
5620 Bremgarten

Phone: +41 56 648 6010
Fax: +41 56 648 6011
mail: welcome@raytech.ch
web: www.raytech.ch

Your local Representative